

DOORS: CARD J1-3

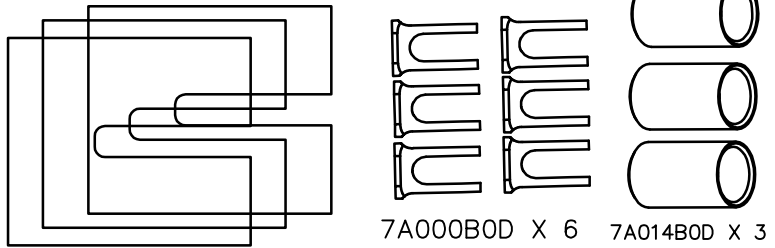

1A087A0D X 3

7A000B0D X 6 7A014B0D X 3

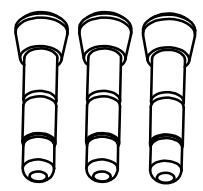

7A014C0D X 3

PH7A002N x6 3/16x3/4unc CapScrews
PH3A001N X 6
MS24693S275 CSK x 6
AN970-3 x 9
BUNDY TUBE 8mm x 6
MS24693S274 CSK x 6
O-RINGS X 3
CIRCLIPS X 3

O'RING BS204 X 3

PH9A010N
DOOR LATCH 3
PACK

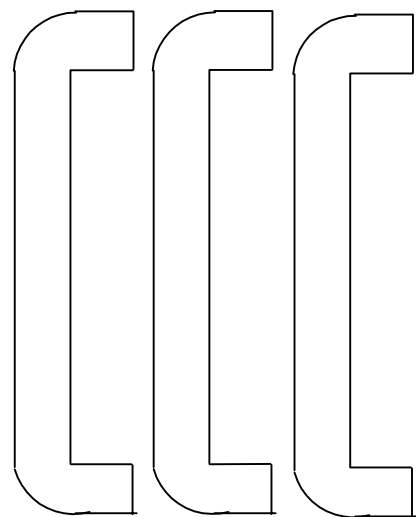

PM5A001N x 3

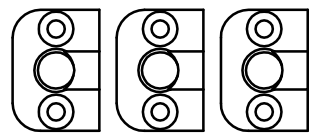

7030014 x 3

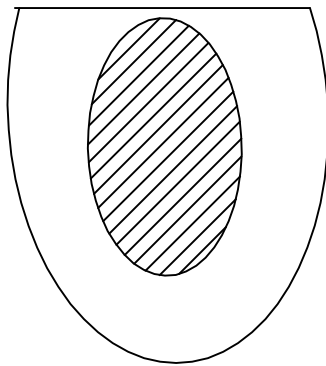
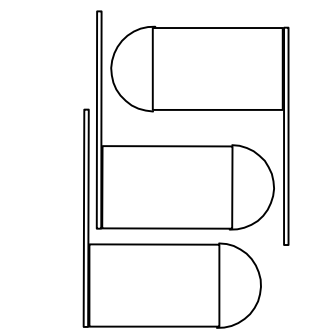

7A026A0N X 3

4.1m DOOR SEAL ATTACHED
4.1m WHITE DOOR SEAL

Door Strap X 1400mm

TRIM SYSTEM: CARD J2-3

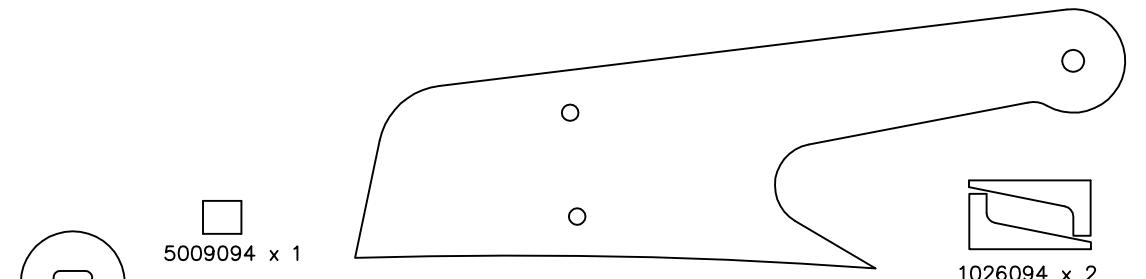

5009094 x 1

1026094 x 2

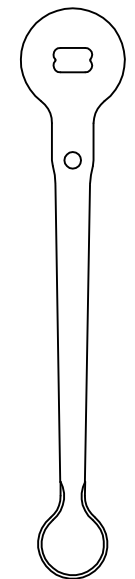

3A060E0D x 2

3A060C0D X 1
Alum Spacer

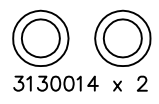
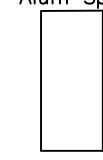

3130014 x 2



3A070A0D X 1
Fibre Glass

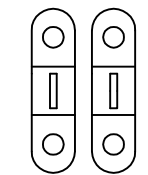

PC0289N x 2

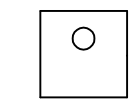

3061094 x 1

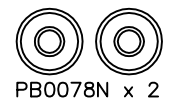

PB0078N x 2

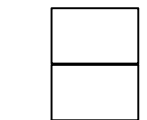

3129014 x 2



3102284 x 1

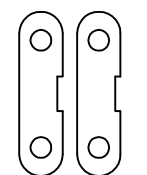

PC0299N x 2

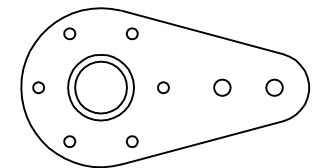

3103184 x 1

3065094 x 1

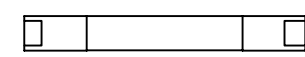

3A060D0D x 1

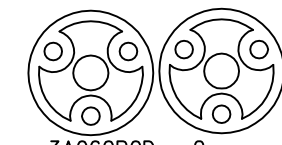

3A060B0D x 2

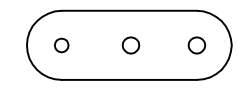

3063094 x 1

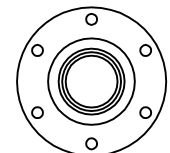

3103284 x 1

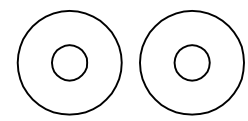

3A048C0D x 2
Friction Washers

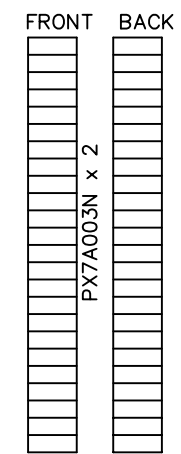

FRONT BACK
PX7A003N x 2

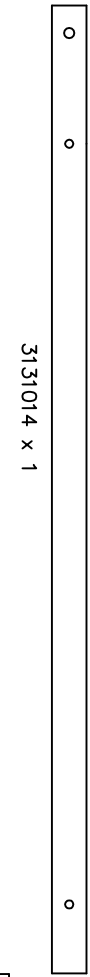

3131014 x 1

AN3-35 x 1
AN310C-3 x 1 castle Nut 3/16
AN960-416 x 1
AN3-10A x 1
MS20365-1032 x 1
PB0009N 3/16 ROD END x 1
AN380-2-2 x 3
AN970-3 x 1 Penny Washer
AN380-1-2 X 1
Bundy Tube 21mm x 1



5A031A0D x 1



5A031B0D x 1

5061054 x 1 (VHF Aerial)

current as on 06-04-09

CARD J3-4: RUDDER

3A084B0D x1

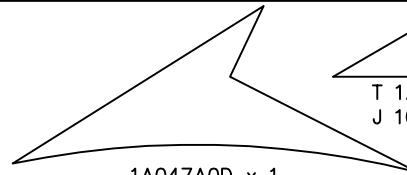
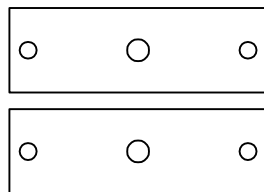
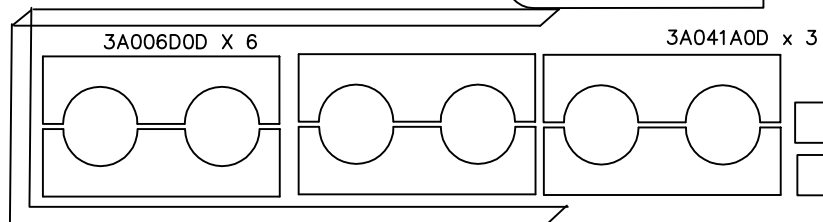

T 1A046A0D x 1
J 1023094 x 1

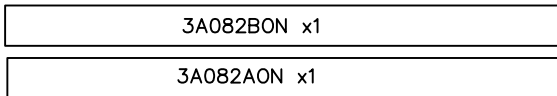

HARDWARE LIST	
PH115434	x 2 CAP SCREW
PH0239N	x 6 (1/4 PLAIN NUTS)
AN4-23A	x 1
AN3-23A	x 2
AN3-25A	x 4
AN4-14A	x 2
AN4-25A	x 3

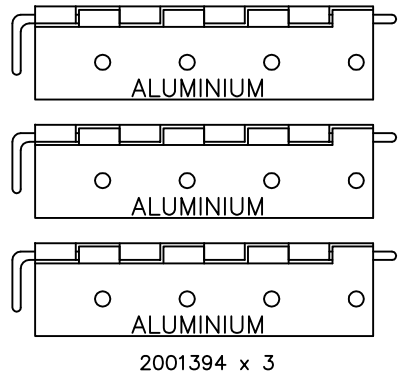
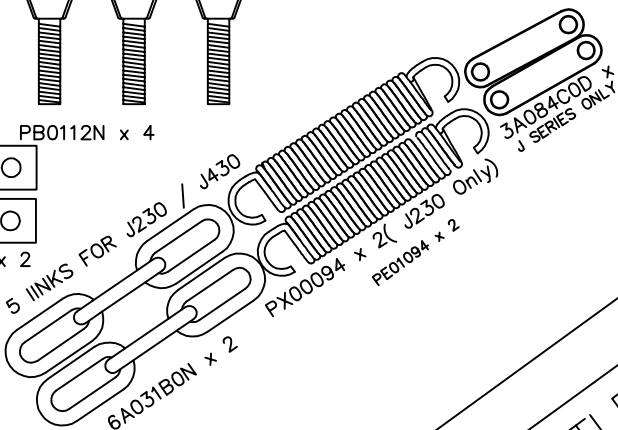
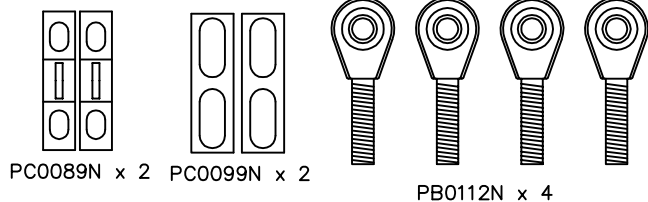

3A005C0D x 1 OR 3A005C1D x 1 (Jumbo)

STANDARD COMPONENTS

JUMBO

current as on 06-04-09

3A005E0D x 2

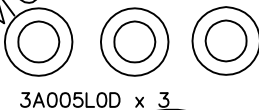
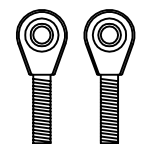
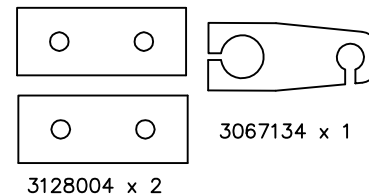
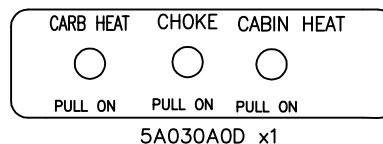
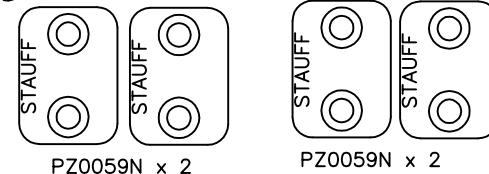
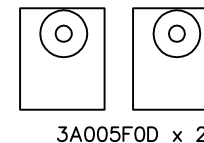

3A005B0D x 2

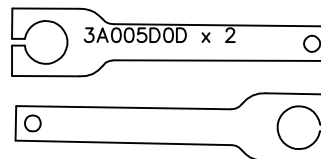

HARDWARE LIST	
AN3-22A	X 2
AN380 2-2	X 1 Split pin
PH0778N	x 3 GRUB SCREW
3/8 x 1 3/4"	BRASS SCREWS X 4
AN4-13A	x 2
AN970-3	x 2 PENNY WASHER
AN3-11A	x 5
Bundy Tube	17mm x 2

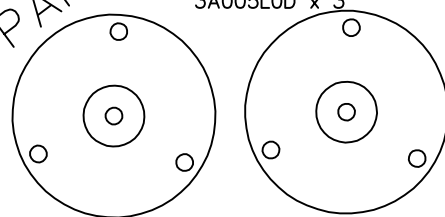

CARD J4-4: PANEL MOUNT THROTTLE

CARD **JIT** 5-3: AILERON SYSTEM current as on 27-4-09

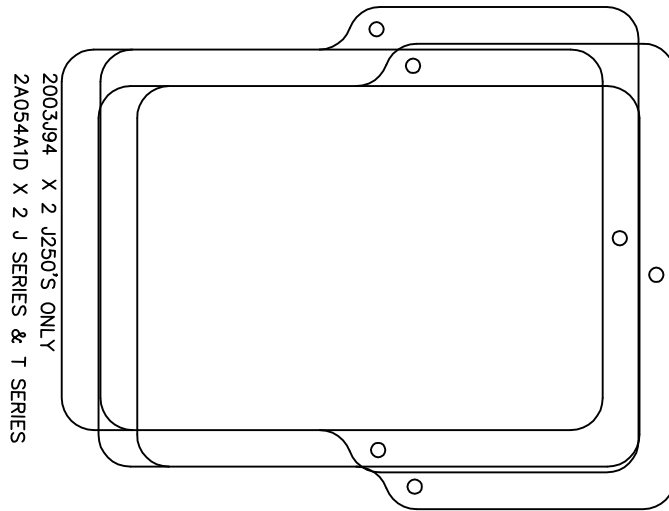

2003094 X 2 J250'S ONLY
2A054A1D X 2 J SERIES & T SERIES

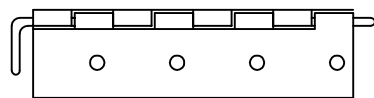
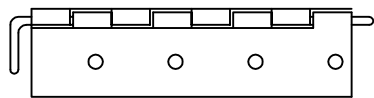
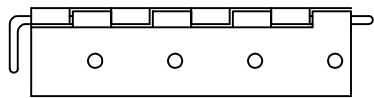

ALUMINIUM

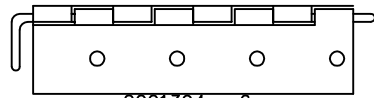

2001394 x 6

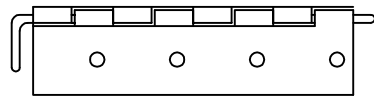

2A080G0D X 12
(only 8 for J170)

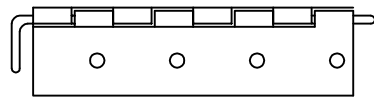

Long Aileron x 6



2A080C0D X 12
(only 8 for J170)

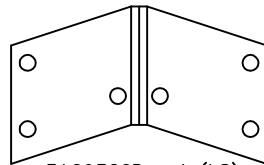

3A093C0D x 1 (LS)
3A093D0N x 1 (RS)



3115094 x 2

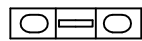

PC0089N x 2



PC0099N x 2



PH0259N R CLIP x 2

CARD **JIT** 6-2: STALL WARNING current as on 27-4-09

PV0029N x 1
8mm Clear Tube x 1800mm

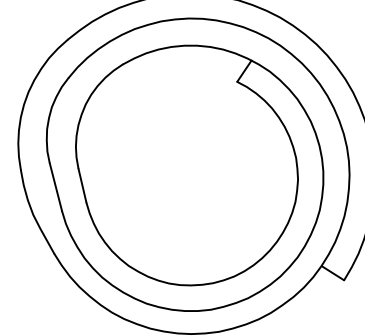

VELCRO (HOOKS ONLY) X 400MM



2082014 x 1



2061294 x 1

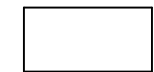

2061394 x 1

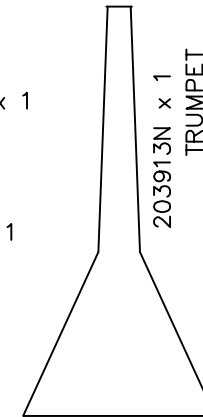

203913N x 1
TRUMPET

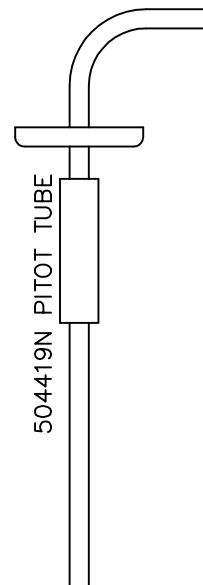

504419N PITOT TUBE

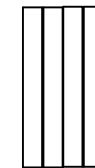

5102094 x 4
STATIC LINE JOINERS 50 mm

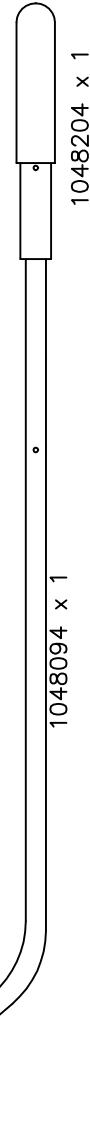

1048204 x 1

1048094 x 1

CARD J7-3: UNDERCARRIAGE

current as on 24-4-09

J DESCRIPTION	QTY
AN3-11A	2
AN4-22A	2
AN4-25A	2
AN6-32 2 SEAT	2
AN6-27 2 SEAT	2
AN6-31 2 SEAT	2

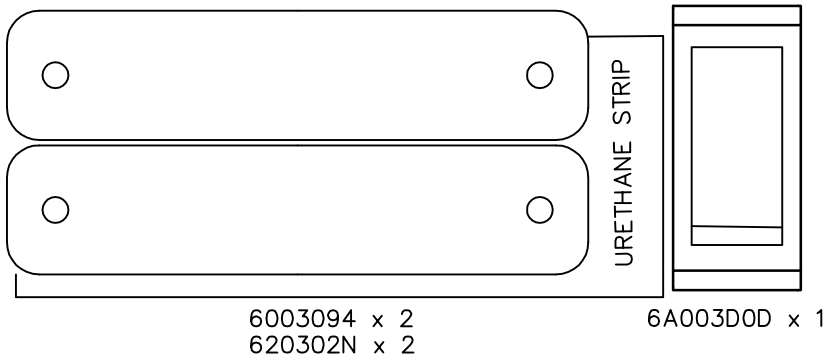
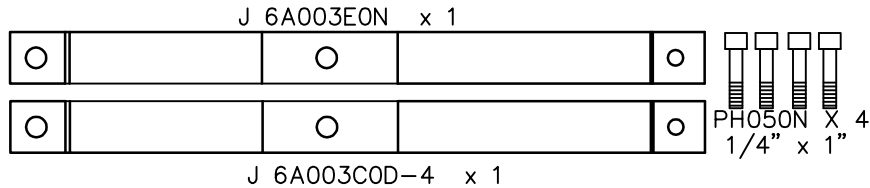
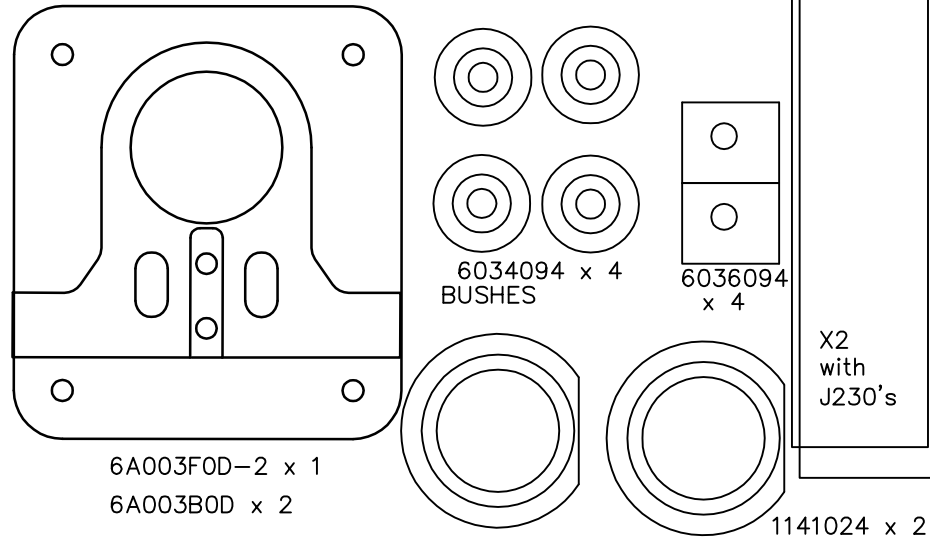
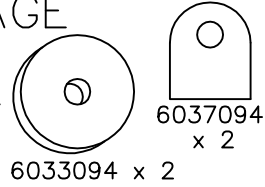

CARD J7-3: UNDERCARRIAGE

current as on 24-4-09

J DESCRIPTION	QTY
AN3-11A	2
AN4-22A	2
AN4-25A	2
AN6-32 2 SEAT	2
AN6-27 2 SEAT	2
AN6-31 2 SEAT	2

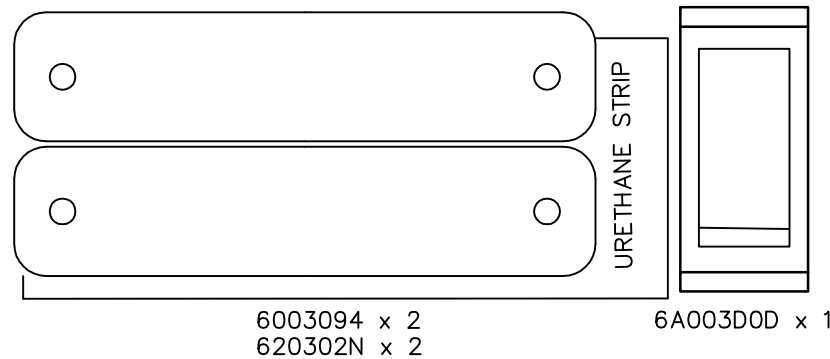
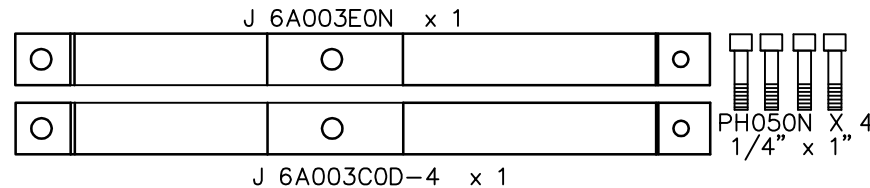
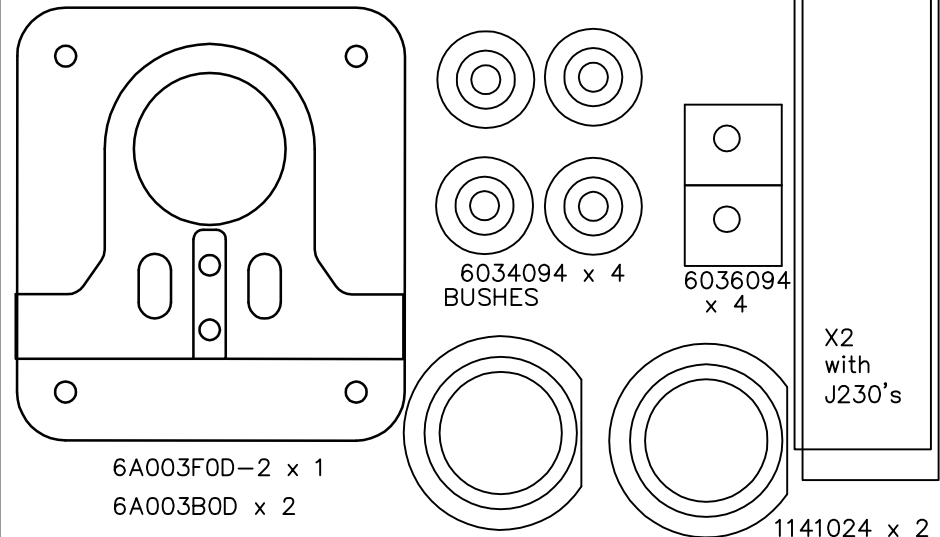
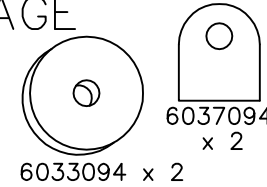

CARD J8-2 : DUAL BRAKES

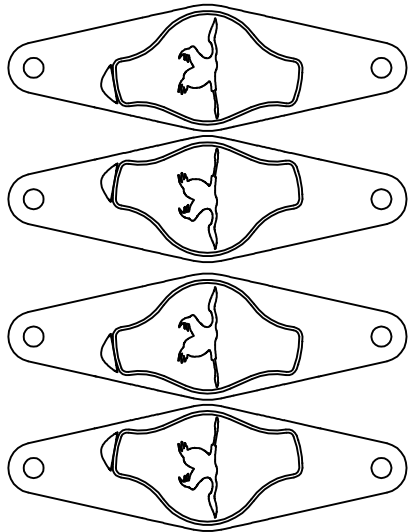

620762N x 2(LH)
6207124 x 2 (RH)

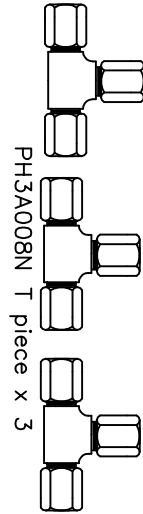

PH3A008N T piece x 3



6207224 x 4
BRAKE PISTON
BREAK HOSE X
3.5M

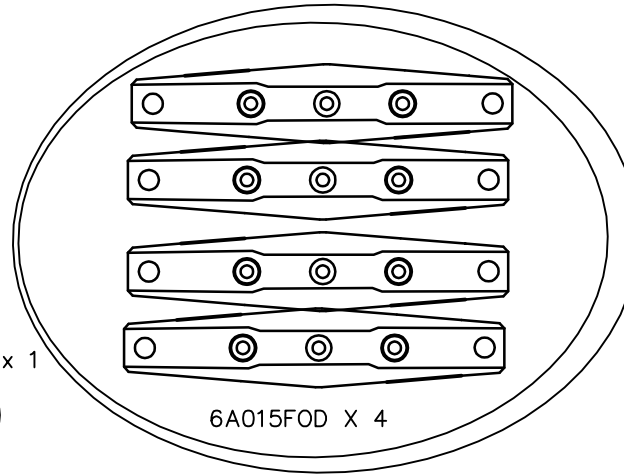

6A015FOD X 4

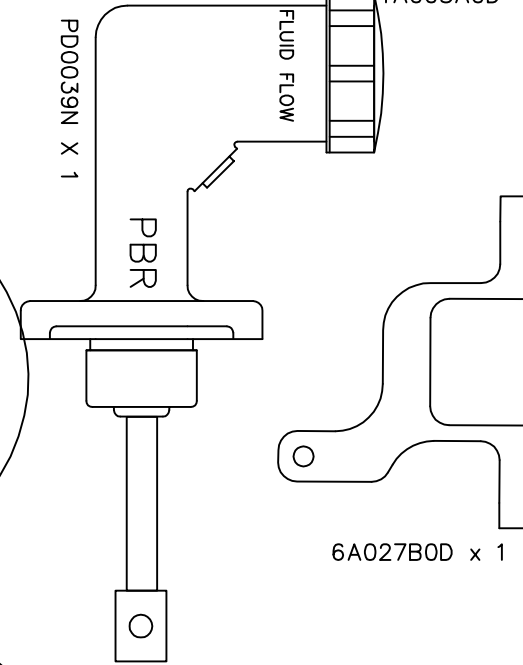

Brake Lever Stop
cover x 1
1A003A0D

6A027B0D x 1

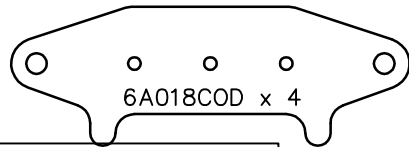

6A018COD x 4



3031094 x 1

3032094 x 1

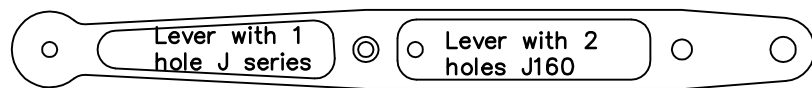

6A027C0D X 1

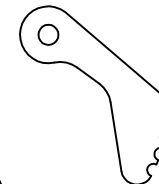

3060094 x 1

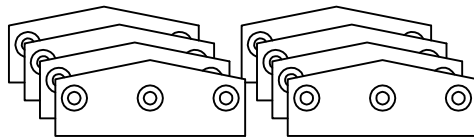

6000994 x 8

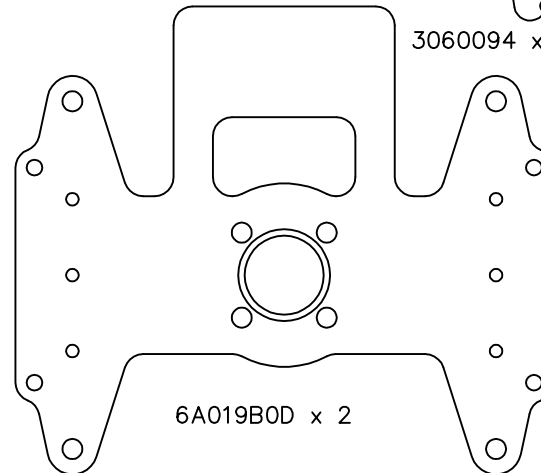

6A019B0D x 2

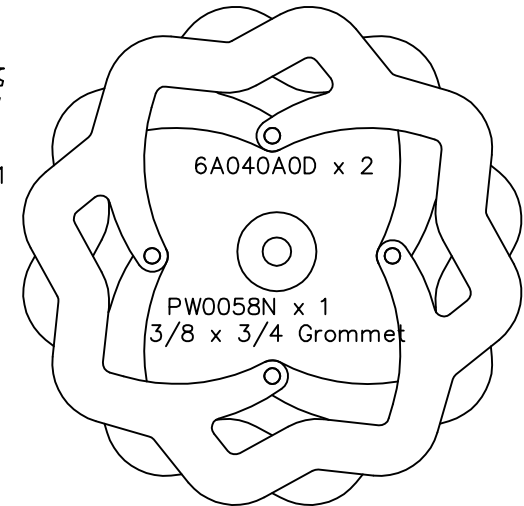

6A040A0D x 2

PW0058N x 1
3/8 x 3/4 Grommet

MASTER CYLINDER
STRAIGHT FITTING
PD00624 X 1

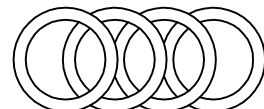

BS0214 x 4 O-RINGS

SMALL PARTS
1/4 unc 1" cap X2
AZ2-03 x 4 BRAKE CYLINDER FITTING
6100094-3 x 4
PH1200N X 14 BRAKE RIVETS
PX0029N X 8 BRAKE SPRINGS
3/16" FERRULE x 4
AN380-2-2 x1 Split pin
3/16 BSW 1 1/2" x 1
1/4 unc X 3/8 capX2
AN4-15A x 8
MS21045-4 x 8
AN960-416 x 8
AN5-10A x 1
AN4-11A X 1
PH1190N X 14 BRAKE RIVETS

CARD J9-2: SEATBELTS

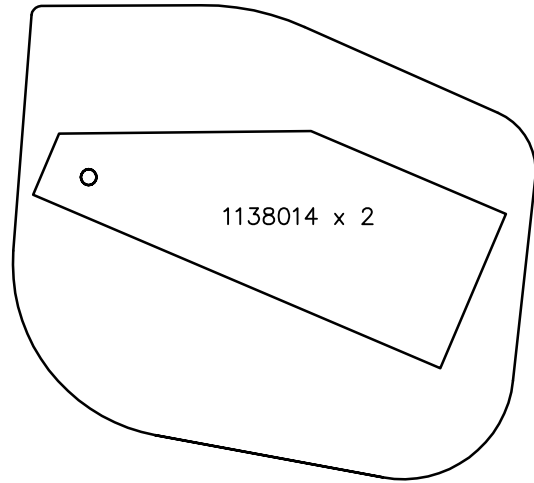

1138014 x 2

1142024 x 2

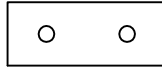
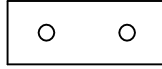

3128004 x 4



1109004 x 6

1A002A0D x 2

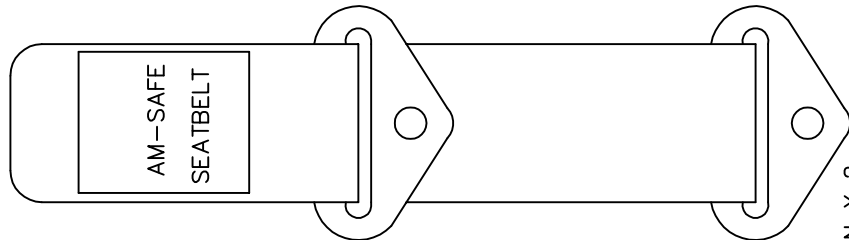

PY6019N X 2

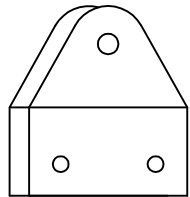
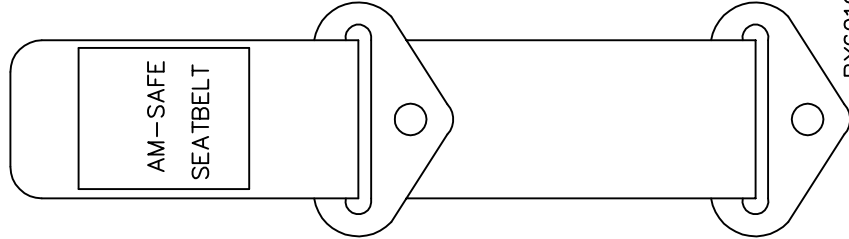

5001094 x 2

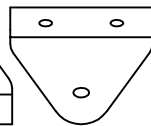
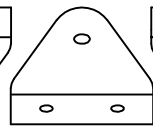
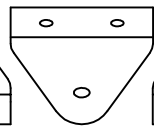
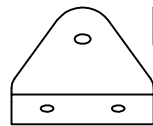

5000094 x 4

CARD J10-2: FIREWALL

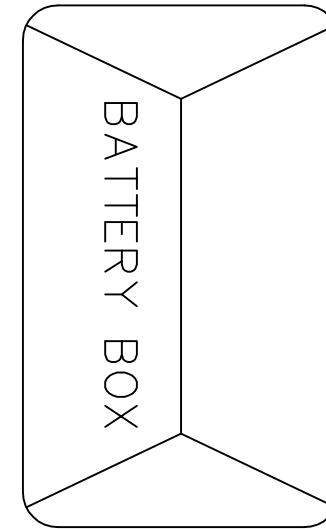

5040094 x 1

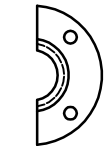
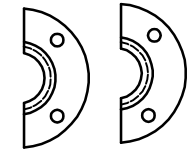

1A071B0D X 4



8-22 HOSE CLAMPS X 2



1042094 x 1

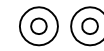

PW0069N x 2
1/2 inch Grommet

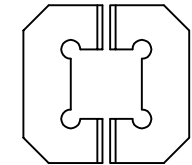

5037094 x 2

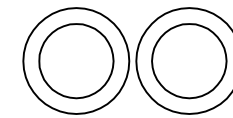

PW0009N x 2
1 1/8 inch Grommet

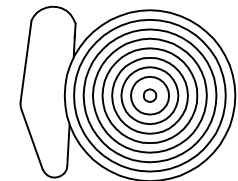

PH9916N x 1

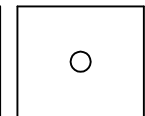
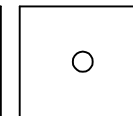
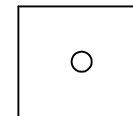
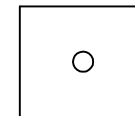

4025094 x 4

CARD J11-3: FUEL COMPONENTS CFI

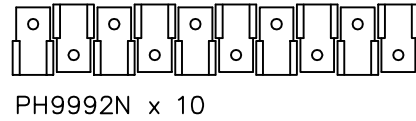
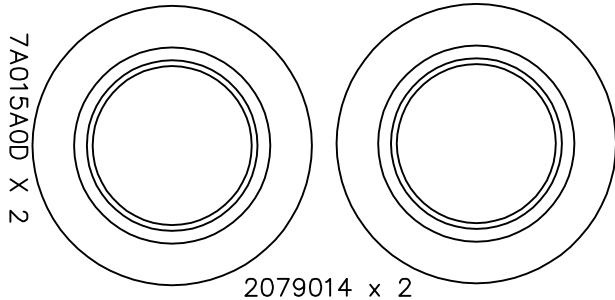

PM0029N x 1

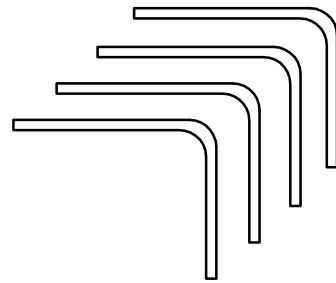
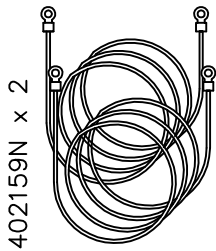
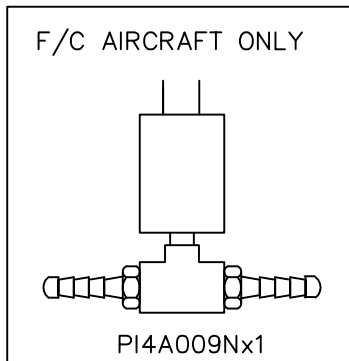
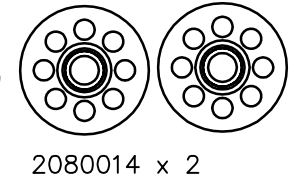
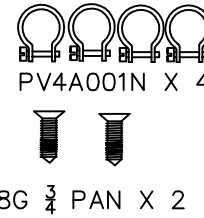
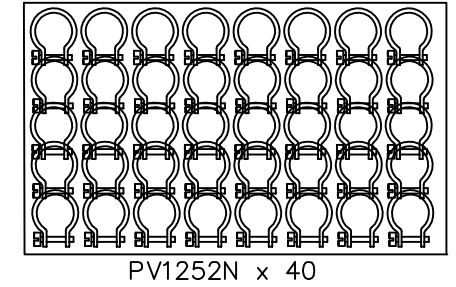
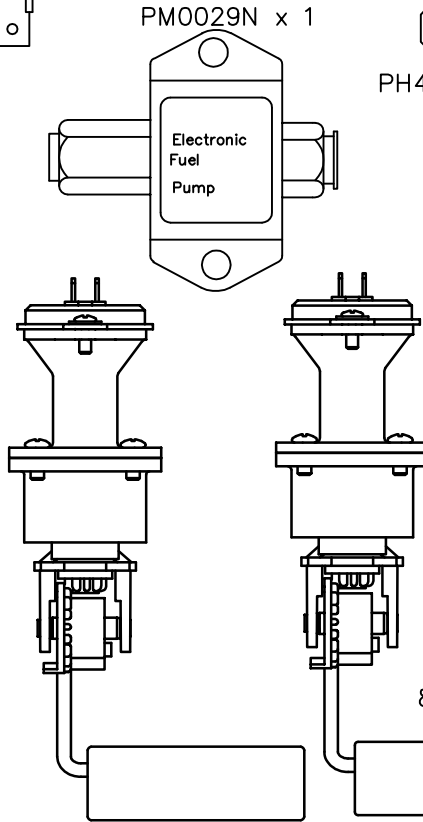
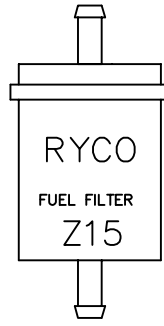
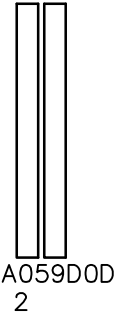
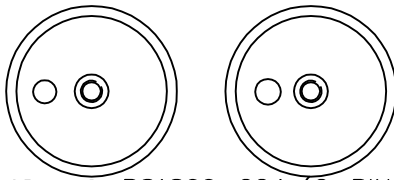
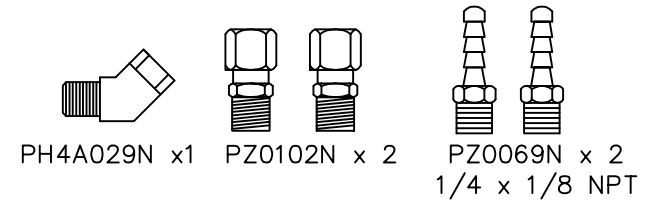

3/16 ALLEN KEY x 1

4A278A0D-1 x 2

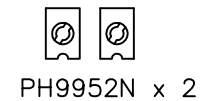
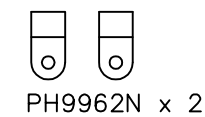
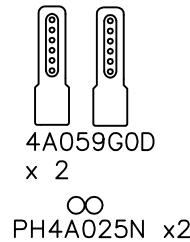
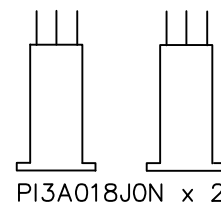
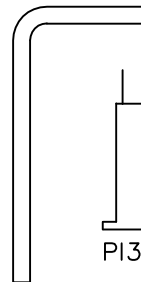
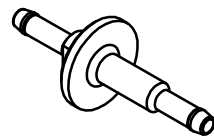
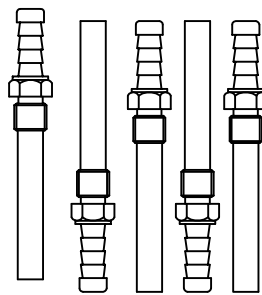
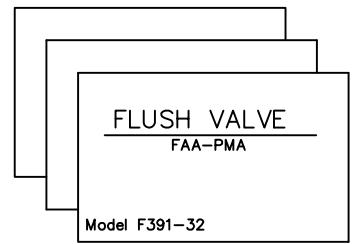

PZ4A005A0N x 2

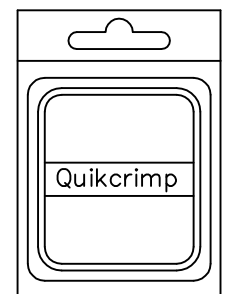
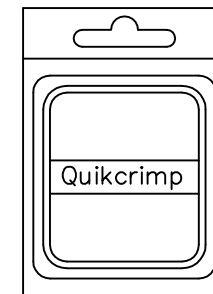

CARD J12-2: FUSELAGE TRIMMINGS

Current as on
14-5-09

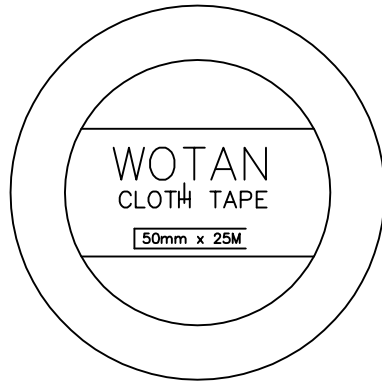

2003093 x 1

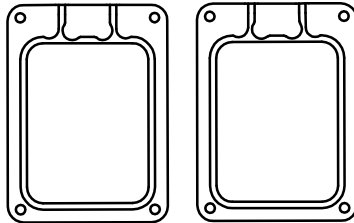

3A069B0D X 2

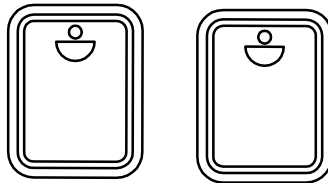

3A069C0D X 2

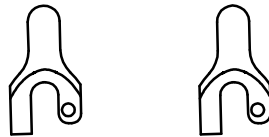

3A069D0D X 2

HARDWARE
M4 NYLOC NUT X 2
M4 x 25Pan X 2 SCREW
PH9H006 X 2 SCREWS

CARD J13-2: COWL COMPONENTS

Current as on
14-5-09

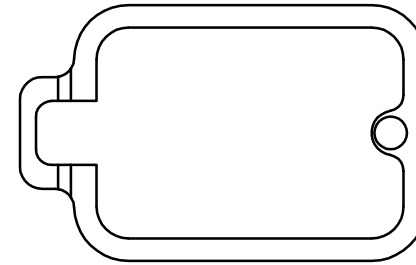

1A081B0D X 1

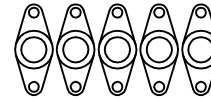

212-12D x 5



2600-6 x 2



2600-8x 3

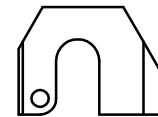

1A081E0D X 1

HARDWARE
PM5A003N X 1 MAGNET
PH9H006 X 2 SCREWS
COTTER PIN X 1

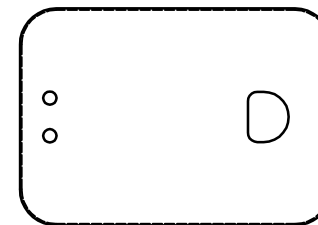

1A081D0D X 1

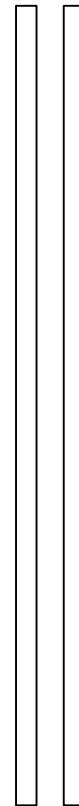

1/4" ALUMINIUM TUBE
x 2 (28cm)

Card JIT 14-2: OPTION 1 & 2 HARDWARE CFI

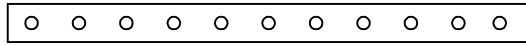

5019094 x 1

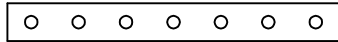

502009N x 1

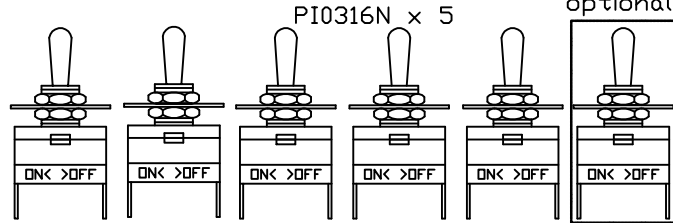

PI3A005A0N X 1
LED PANEL GREEN

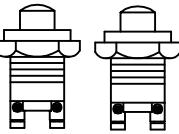

PI3A004A0N X 2
LED PANEL RED

PI0170N x 1
PI0169N x 1
(ALT)

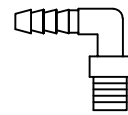

PI0172N x 2
A.S.I

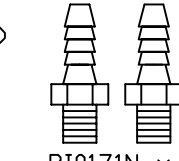

PI0171N x 1
(ALT)

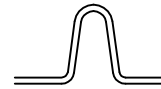

PV4A003N X 1

DESCRIPTION	QTY
AN960-10-Full Washer	13
PI3A019A0N isolators	2
MS21069-L08 RETAINERS	8
MS21045-3	5
PH3A009N M3 X 8 PAN	10
AN3 12A	5
MS35206-245	8
TAPK 3-3 Rivet	16
MS21044B06 Campuss Nut	8
5/32 BRASS WASHER	3
5105004 threaded washer	5
PH0419N M4x12PH Screw	30
M4 NYLOC NUTS	30
MS35214-30 Black Screws	17
MS3373-16C Alien Nut	14
PW0058N Grommet	5
MS35214-26 Black Screws	30

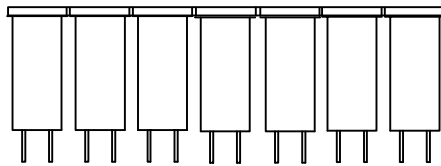

15A Circuit Breaker x1
10A Circuit Breaker x2
5A Circuit Breaker x4

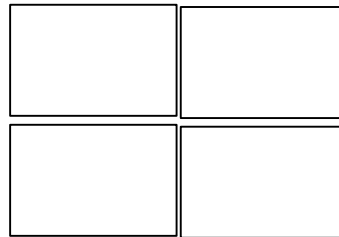

PI4A01N x 2
Suppressor

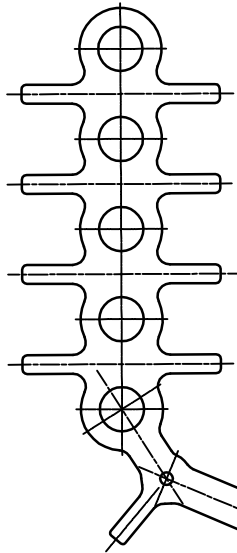

PI0306N x 1
Starter

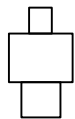

Female BNCx1
2164514 crimp
type

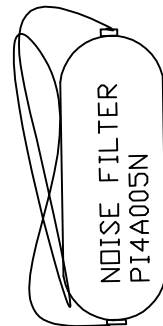

NOISE FILTER
PI4A005N

Electrical List:	
Red Spade Female	X 110
Blue Spade Female	X 12
Yellow Spade Female	X 16
Red Spade Male	X 10
Red Ring 4mm	X 20
Red Ring 6mm	X 4
Blue Ring 4mm	X 3
Blue Ring 5mm	X 2
Blue Ring 8mm	X 1
Yellow Ring 5mm	X 7
Yellow Ring 6mm	X 5
Yellow Ring 8mm	X 5

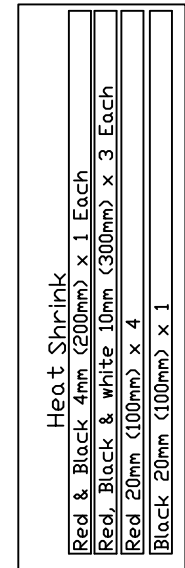
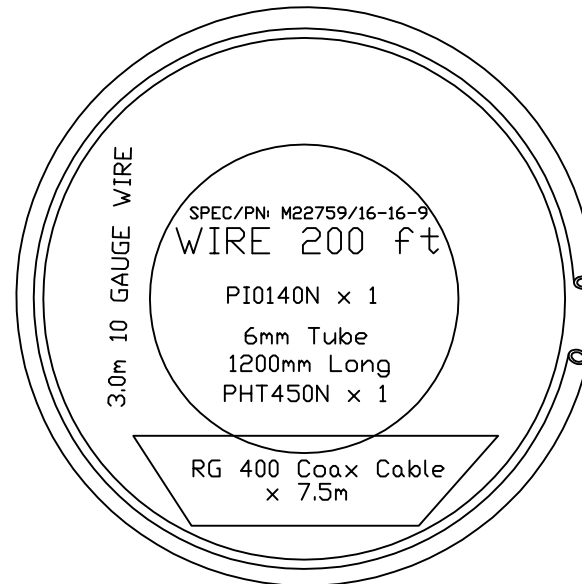

5A020E0D X 1

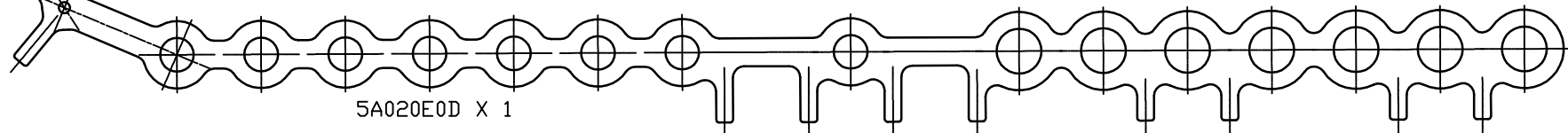

Card J17 14-3: OPTION 3&4 HARDWARE

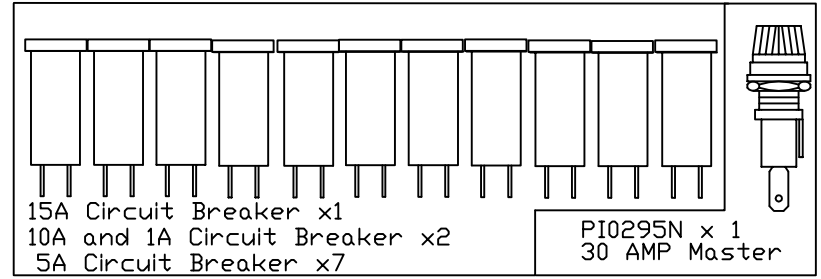
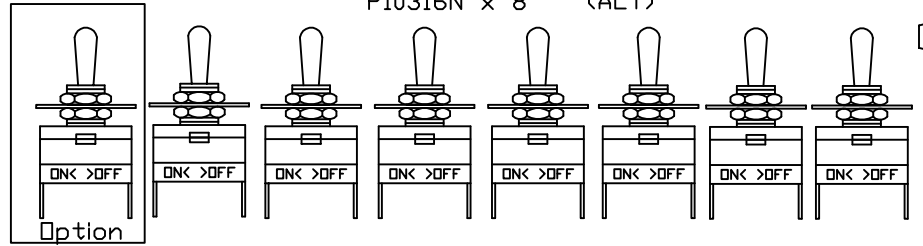
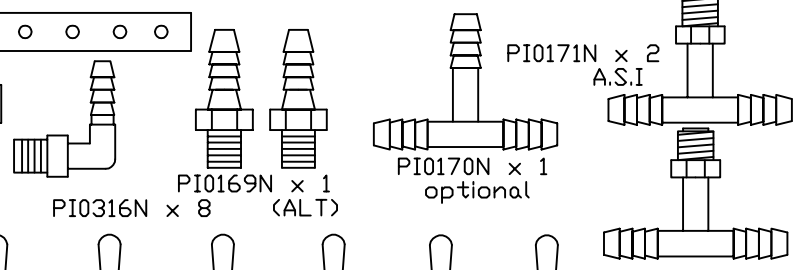
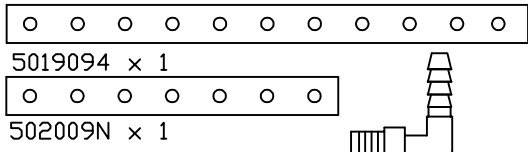

Electrical List:

Red Spade Female X 110	7
Blue Spade Female X 12	13
Yellow Spade Female X 16	2
Red Bullet Male X 1	8
Red Spade Male X 10	7
Red Ring 4mm X 20	7
Red Ring 6mm X 4	7
Blue Ring 4mm x 3	8
Blue Ring 5mm X 2	3
Blue Ring 8mm X 1	3
Yellow Ring 5mm X 7	3
Yellow Ring 6mm X 5	16
Yellow Ring 8mm X 5	30

DESCRIPTION	QTY
PW0058N Grommets	7
AN960-10-Full Washer	13
PI3A019A0N	2
MS21069-L08 RETAINERS	8
MS21045-3	7
5105004 Threaded Washer	7
AN3 12A	7
MS35206-245	8
MS35214-29	3
MS21044B06	3
5/32 BRASS WASHER	3
TAPK 3-3	16
M4 x 12 PH	30
M4 NYLOC NUTS	30
MS35214-31 Screws	14
MS3373-16CNuts	14
PH3A009N M3 X 8 PAN	10

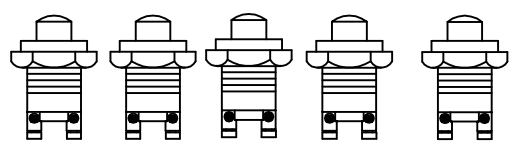
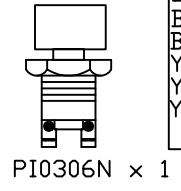

Female BNCx1
2164514 crimp
type

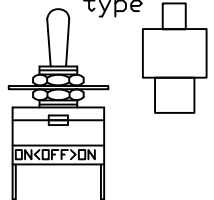

Landing Light
switch(NVFR)

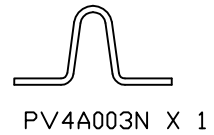

5A043H0D - 3PIECE
BUS BAR

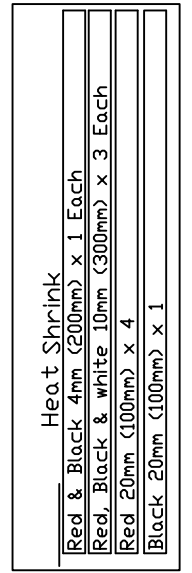
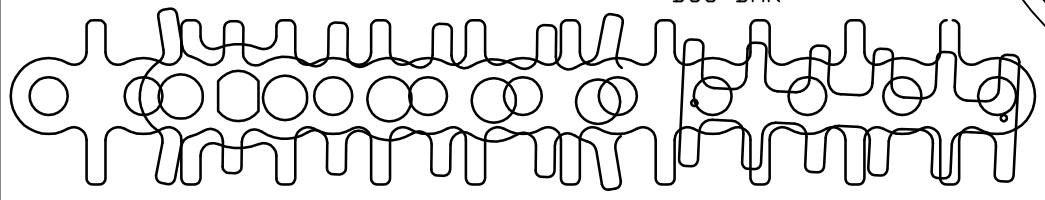
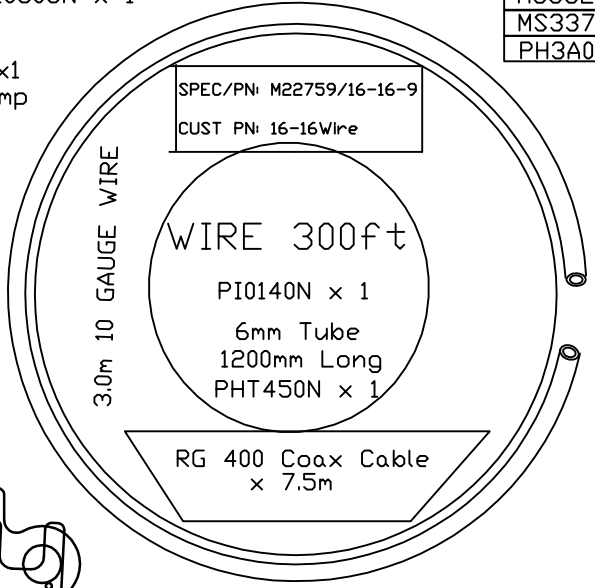

Card JIT 14-3: OPTION 5 HARDWARE

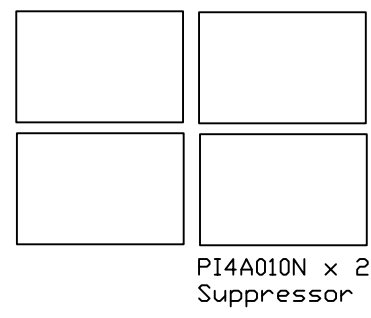
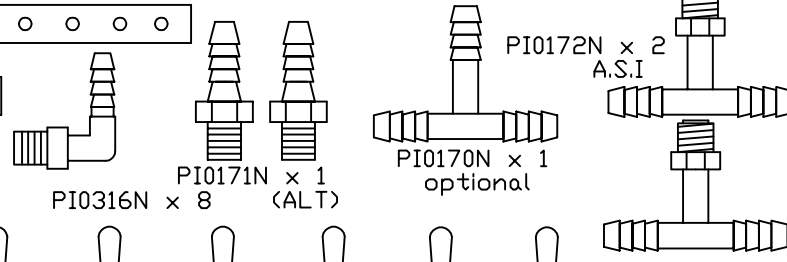
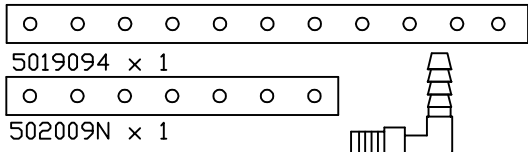

INSTRUMENT DIMMER
COMPONENTS PACK

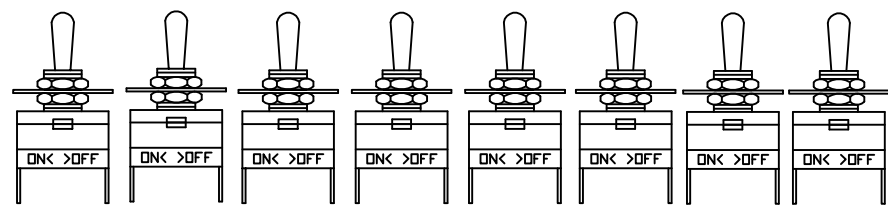

Electrical List:

- Red Spade Female X 110
- Blue Spade Female X 12
- Yellow Spade Female X 16
- Red Bullet Male X 1
- Red Spade Male X 10
- Red Ring 4mm X 20
- Red Ring 6mm X 4
- Blue Ring 4mm x 3
- Blue Ring 5mm X 2
- Blue Ring 8mm X 1
- Yellow Ring 5mm X 7
- Yellow Ring 6mm X 5
- Yellow Ring 8mm X 5

DESCRIPTION	QTY
PW0058N Grommets	7
AN960-10-Full Washer	13
PI3A019A0N ISOLATORS	2
MS21069-L08 RETAINERS	8
MS21045-3 HEAT NUTS	7
5105004 Threaded Washer	7
AN3 12A	7
MS35206-245 SCREWS	8
MS35214-29	3
MS21044B06	3
5/32 BRASS WASHER	3
TAPK 3-3	16
M4 x 12 PH	30
M4 NYLOC NUTS	30
MS35214-31 Screws	14
MS3373-16CNuts	14
PH3A009N M3 X 8 PAN	10

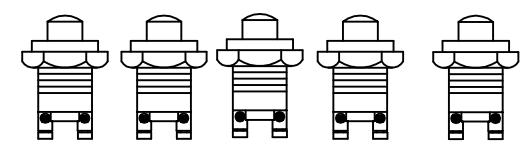
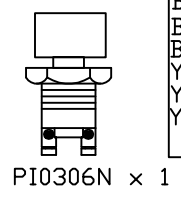
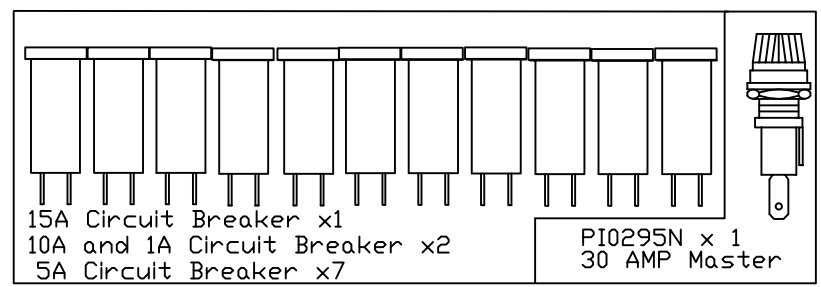

Female BNCx1
2164514 crimp
type

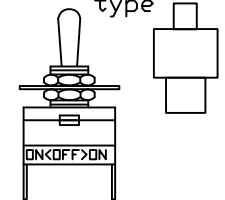

Landing Light
switch(NVFR)

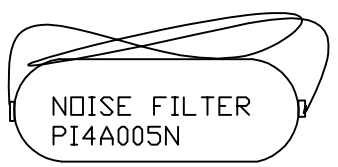

5A043H0D - 3PIECE
BUS BAR

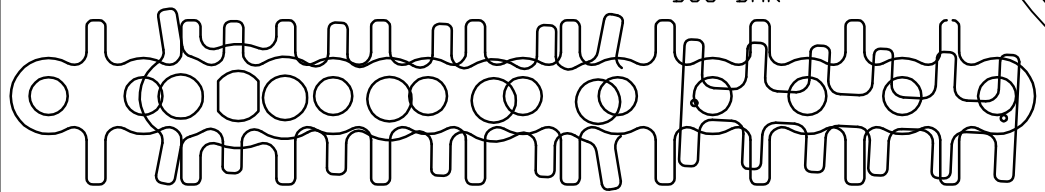
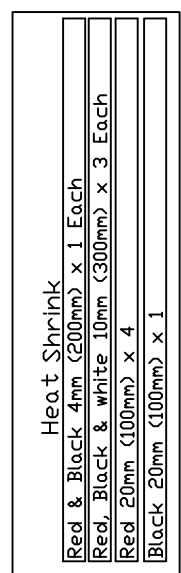
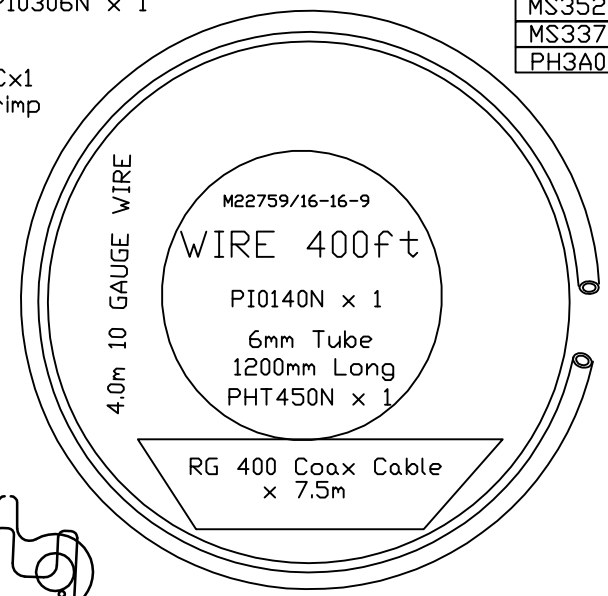

CARD J15B-2: SPARES CFI

Bundy Tube 1 to 6mm x 1
 Bundy Tube 10mm x 4
 Bundy Tube 19mm x 1

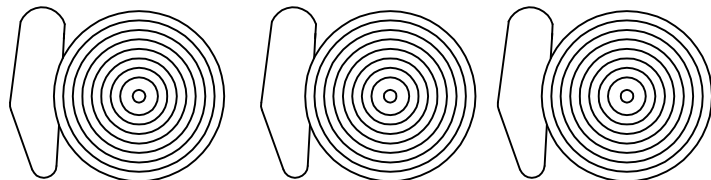

PH9916N x 3

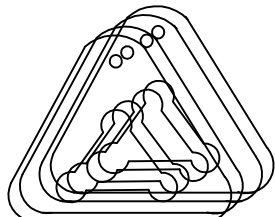

4009094 x 4
 PH4A032N X 10
 SPRINGS

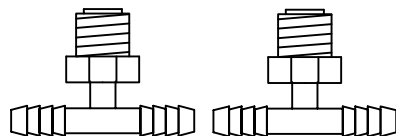

PI13190N X 2 Blue Water
 Traps



2A052A0D X 2



AN5-10A X 2

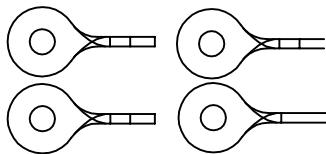
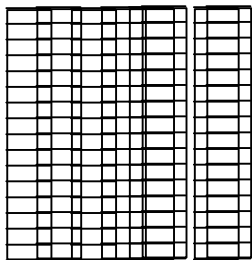

110824 X 4

Bullet Terminal x 1

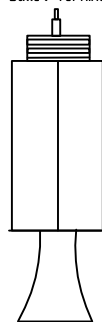

Cigarette
 Lighter X 1
 Red Bullet x 1

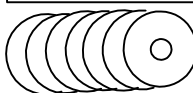
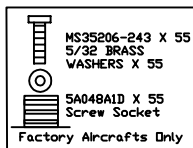

970-4 washers x 7
 4MM CLEAR TUBE X0.5M

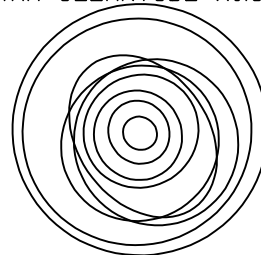

FUEL LINE SHEATHING X 4.3M

PH0868N x 20
 Black 12 inch Zip Ties

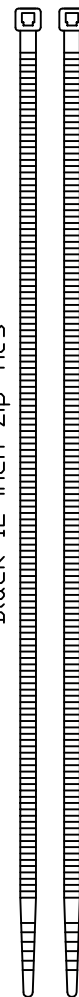

PH0858N x 20
 White 11 3/8 inch Zip Ties

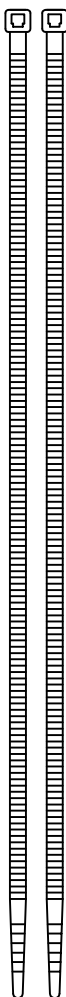

PH0848N x 40
 Black 8 inch Zip Ties



PH0838N x 1 PACK
 Black 4 inch Zip Ties



INSERTION RUBBER 120 X 300

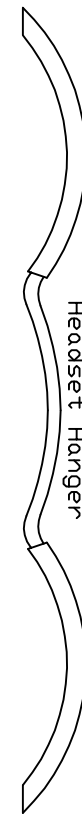

PI0149N x 1
 Headset Hanger

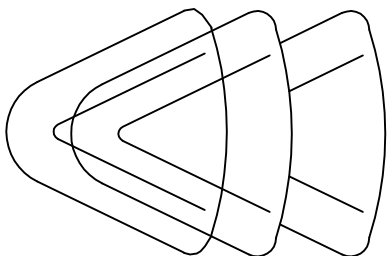

1037094 x 3
 AIR SCOOPS

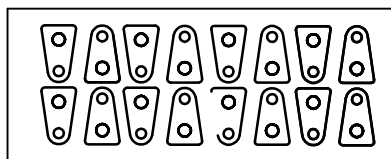

2001594 X 1

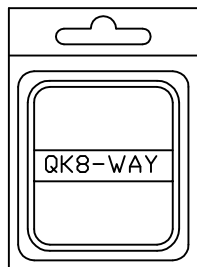

QK8-WAY X1

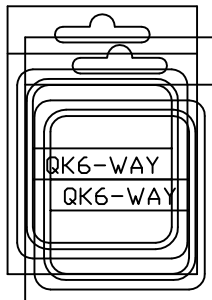

QK6-WAY X2

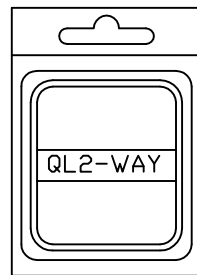

QL2-WAY X1

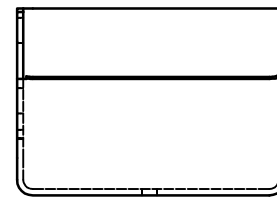

4984124 x 1
 Drip Tray

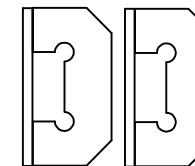

5037094 X 2

3A065A0D X 1

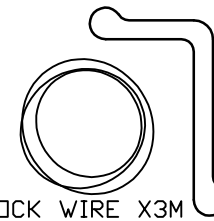

LOCK WIRE X3M

CARD J16-4 : ELECTRIC FLAPS current as on 06-04-09

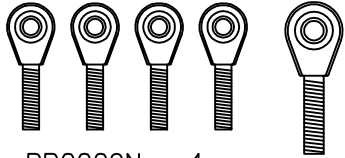

PB0009N x 4
3/16 ROD END

PB0112N x 1
1/4 ROD END

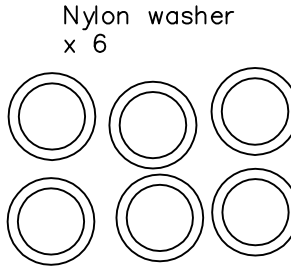

Nylon washer
x 6

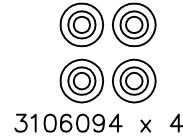

3106094 x 4

DESCRIPTION	QTY	DESCRIPTION	QTY
AN960-416L-Half Washer	4	AN3-13A-Bolts	3
AN960-416-Full Washer	7	MS20365-1032-Nut Nyloc	4
AN316-3-Half Nut	6	PH9962N-P Clamp white	4
AN960-10-Full Washer	8	AN3-7A-Bolts	6
AN960-10L-Half Washer	4	AN3-10A-Bolts	2
MS20365-428-Nut Nyloc	2	MALE SPADE TERMINAL RED	2
AN4-11A-Bolt	1	FEMALE SPADE TERMINAL RED	2
PH0239N (1/4 UNF Plain)	1	Bundy tube 19mm	1
AN316-5R 5/16 HALF NUT	2	3000B94 Spacer Rod	3
AN3-16 M/16" BOLT DRLD	1	AN960-516-Full Washer	1
3A055HOD FLAP DRV MNT	1	Bundy Tube 8mm	8
3A085BOD-SharftIndacater	1		
3A085COD-Indacaterwasher	1		

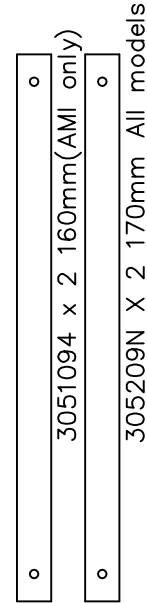

3051094 x 2 160mm(AMI only)

305209N X 2 170mm All models

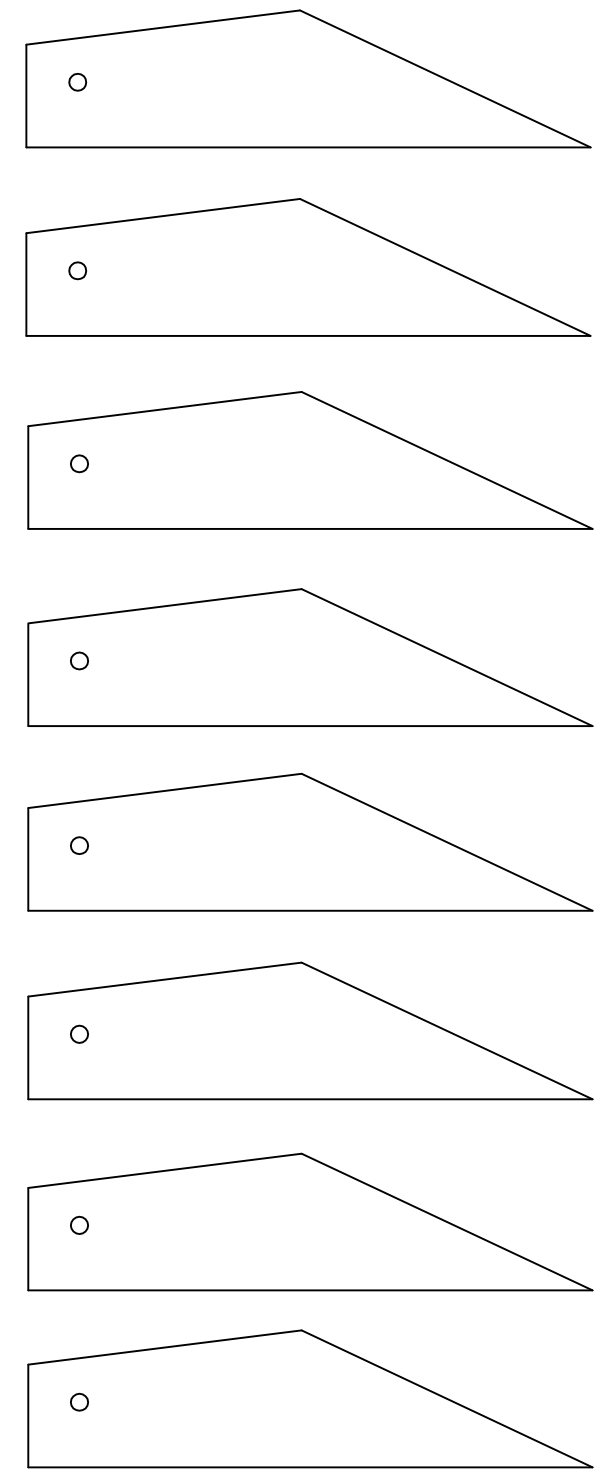

2026094 x 8

PC3A002 (Choke Cable
Inner and outer)x1

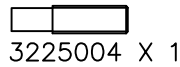

3225004 X 1

3A062BOD-2
X1

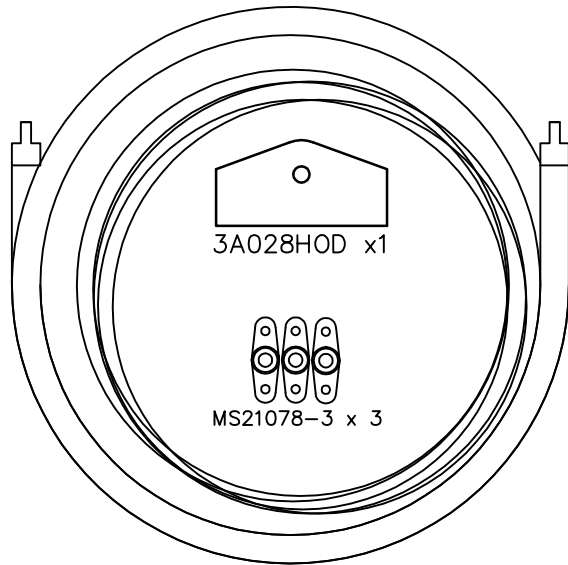
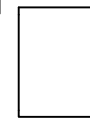

3A028HOD x1

MS21078-3 x 3

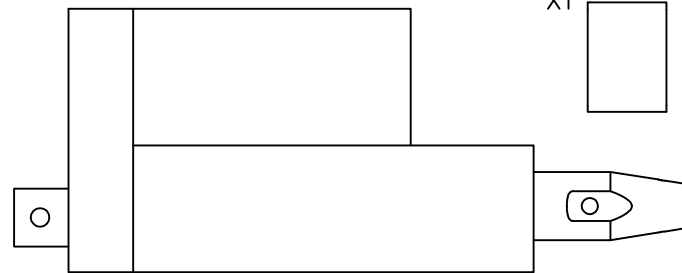

PM3A000N x 1 (ELECTRIC FLAP DRIVE)

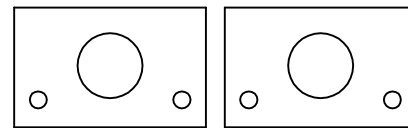

3003394 x 2

PI3A003A0N-1x1

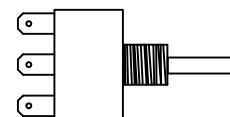

CARD JIT 17B-2: ELEVATOR SYSTEM AND CONTROL STICK CFI



J SERIES 3A093BOD X 1 T SERIES 3A081BOD X 1

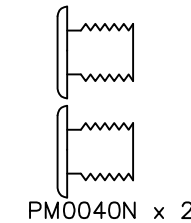
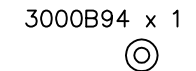
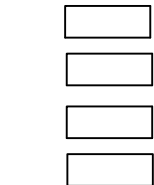
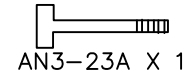
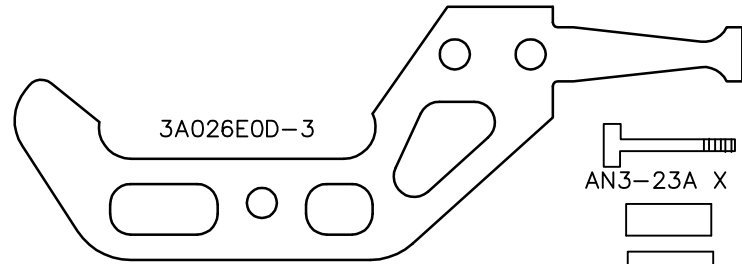
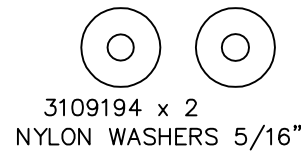
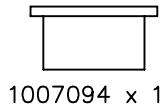
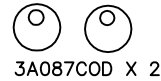
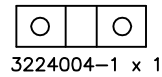
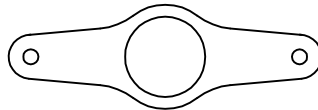
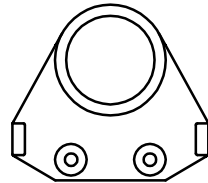
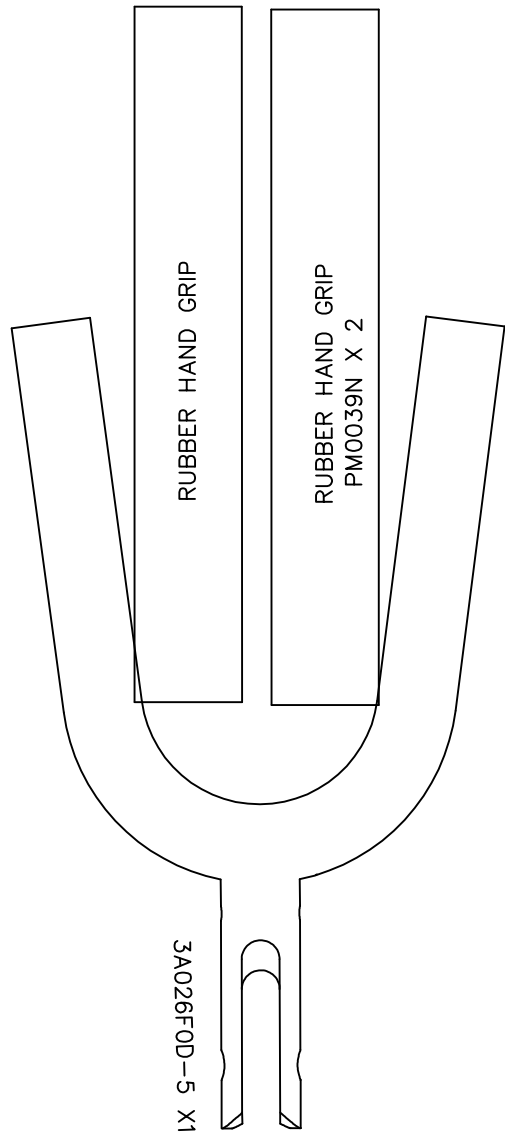

Spiral Wrap x 150mm

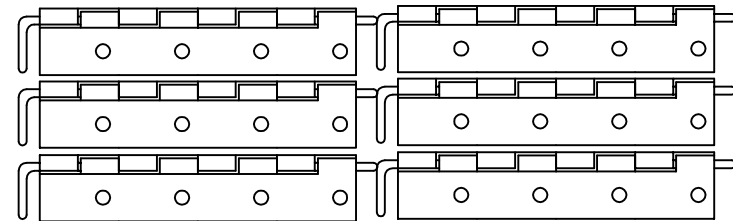
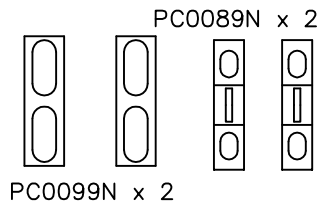

CARD J19-3 : NOSELEG Current as on 20-4-09

DESCRIPTIONS:	QTY:
1 AN5-43 BOLT	1
2 AN5-15A BOLT	1
3 AN3-7A BOLT	1
4 AN3-6A BOLT	1
5 AN3-22A BOLT	3
6 AN310-5 NUT	1
7 MS20365-1032 NUT	4
8 AN960-1032 WASHER	3
9 AN960-516 WASHER	6
10 AN380-2-2 SPLIT PIN	1
11 MS20365-428 NUT	2
12 MS20365-524 NUT	1
13 AN960-416 WASHER	2
14 AN4-16A BOLT	1
15 AN970-4	1

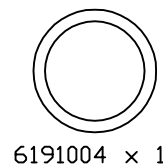
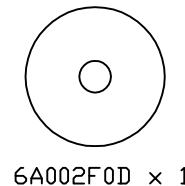
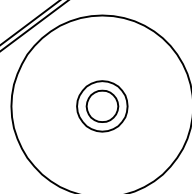
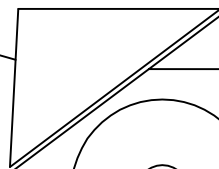
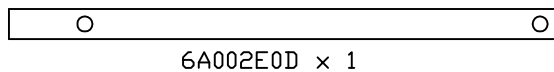
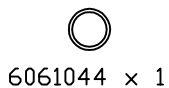
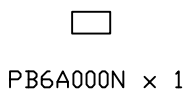
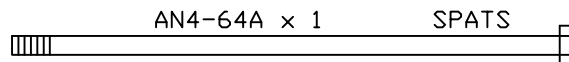
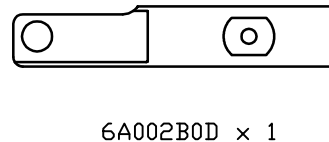
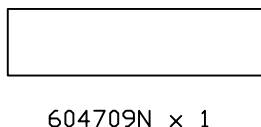
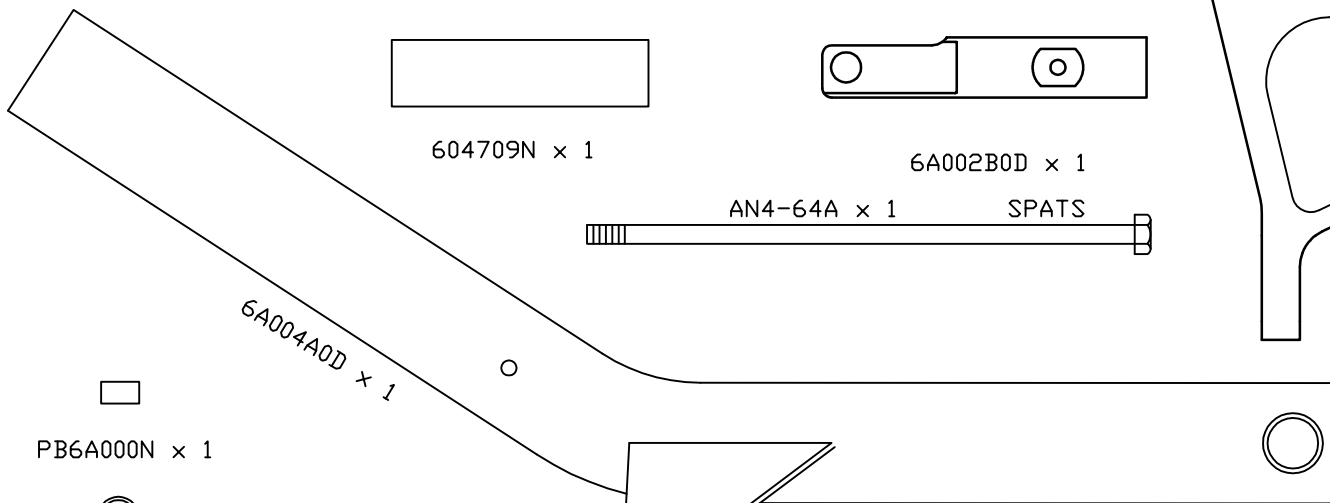
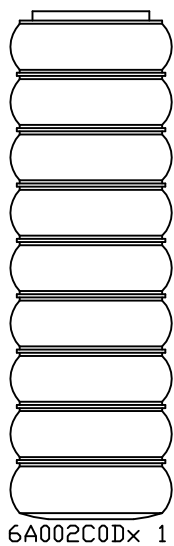
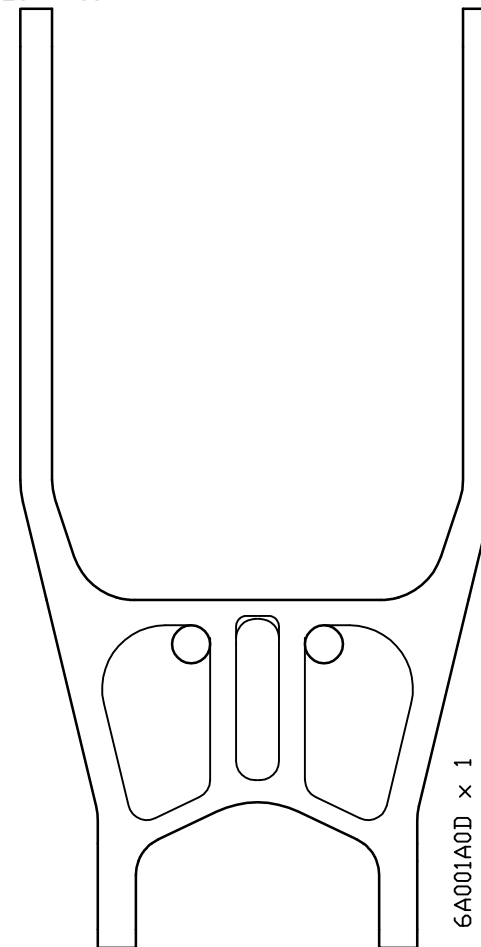
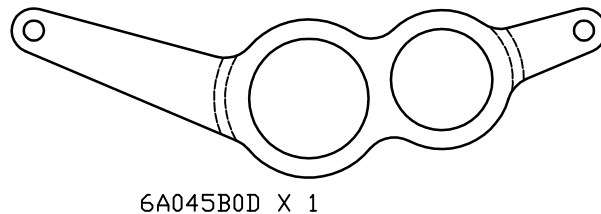
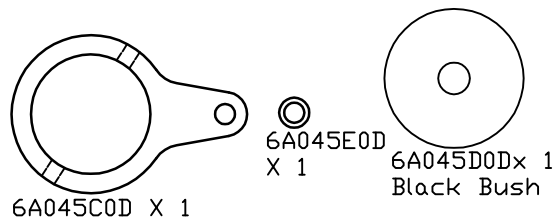

CARD **J|T** 20: NOSEWHEEL

6213123-1 x 1

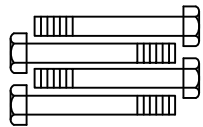

AN4-11A x 4



AN960-416 x 8



MS20365-428x 4

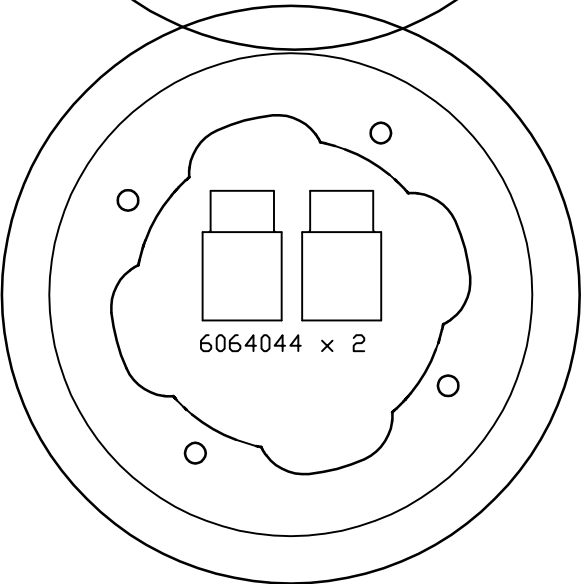
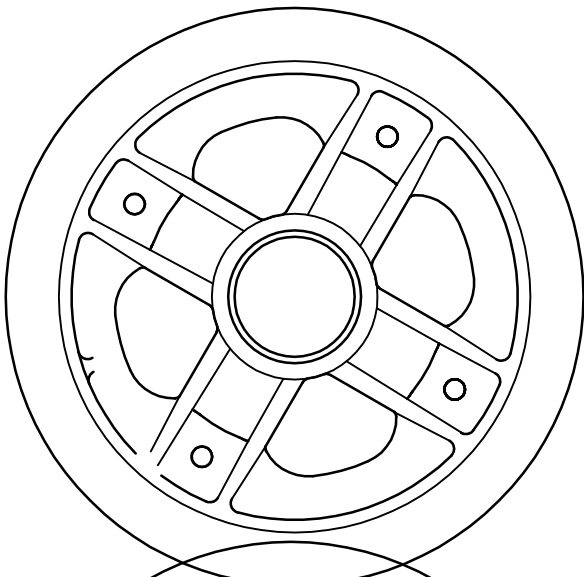

6211023-2 x 1



AXLE

6065044 x 1

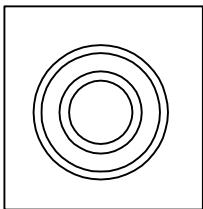

PB0029N x 2
BEARINGS

CARD **J|T** 20: NOSEWHEEL

6211023-2 x 1

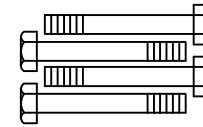

AN4-11A x 4



AN960-416 x 8



MS20365-428x 4

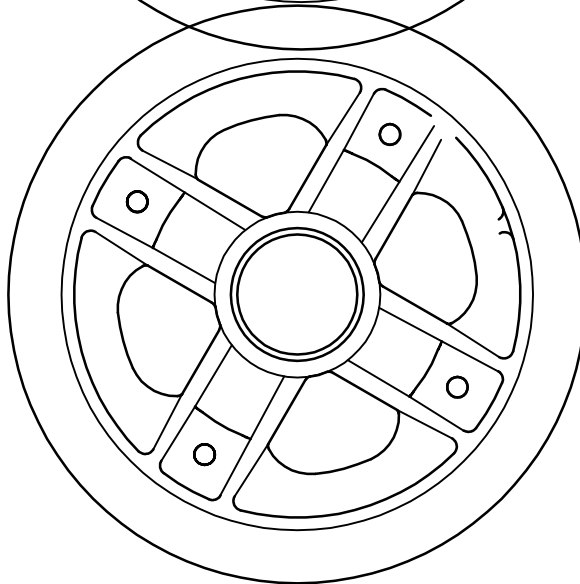
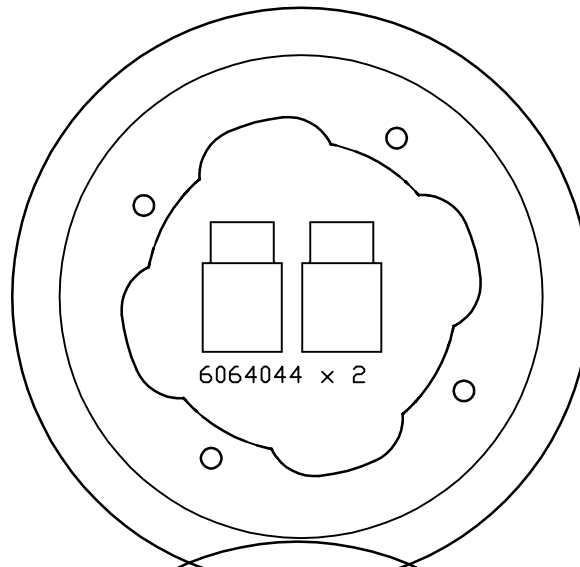

6213123-1 x 1



AXLE

6065044 x 1

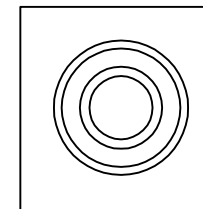

PB0029N x 2
BEARINGS

CARD J | T 21-2: MAIN WHEELS

PW0009N x 3
1 1/8 Grommet

6211023-2 x 1

6210023-2 x 1

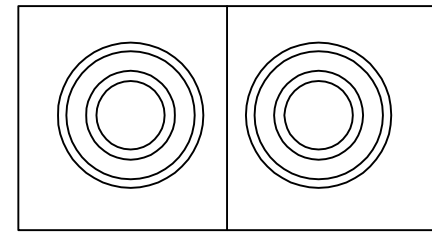
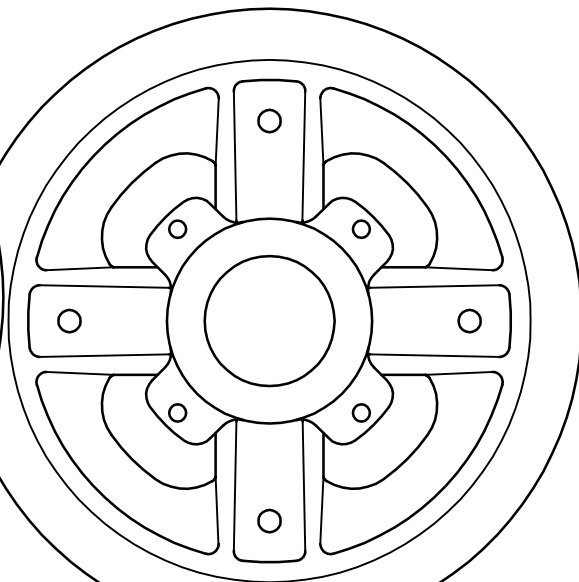
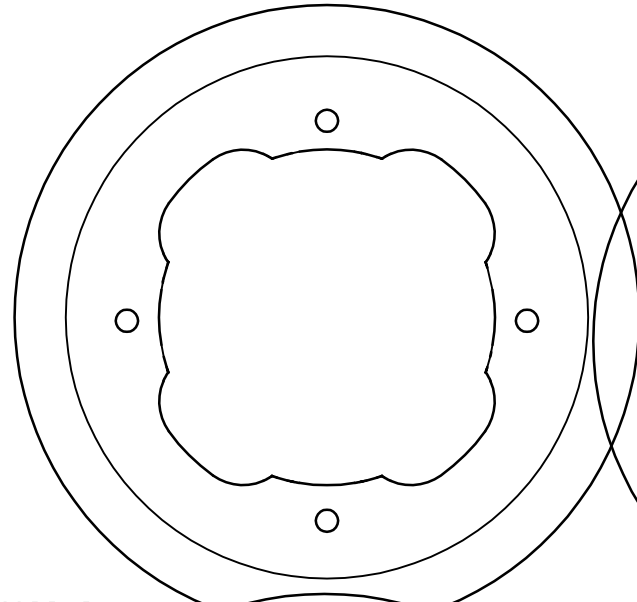

PB0029N x 4 (BEARINGS)

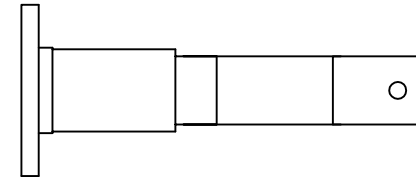

6A028B0D x 2

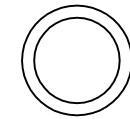

6A028C0D x 2

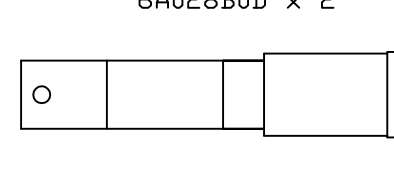

6210023-2 x 1

6211023-2 x 1

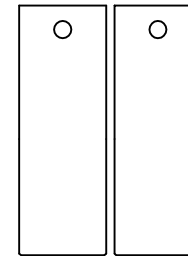
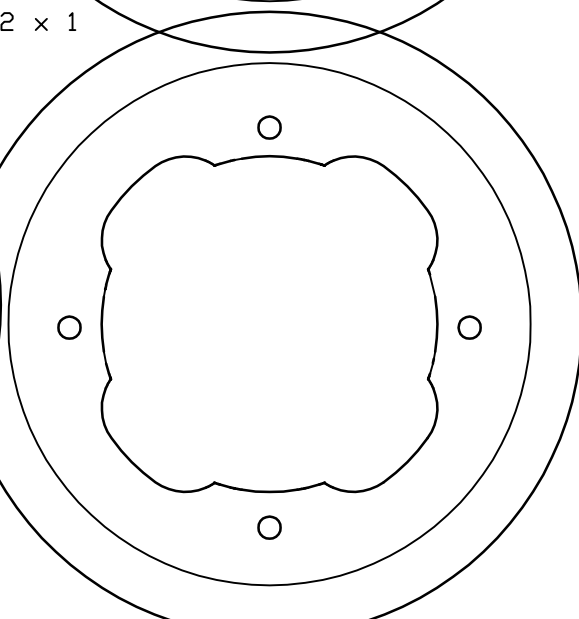
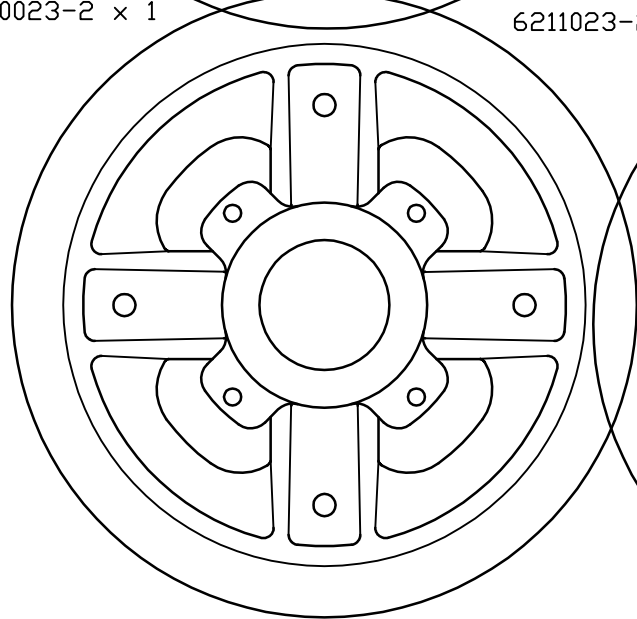

6000594 x 2

HD STUB AXLES

	DESCRIPTIONS:	QTY:
1	AN4-11A BOLT	8
2	MS20365-428 NUT	8
3	AN960-416 WASHER	16
4	AN5-15A BOLT	4
5	AN5-16A BOLT	4
6	AN960-516 WASHER	22
7	MS20365-524 NUT	8
8	MS21047-3	8
9	A3235-020-935	8
10	MS246935273	8
11	AN4-4A	2
12	AN960-416L	4
13	MS24693C47	10

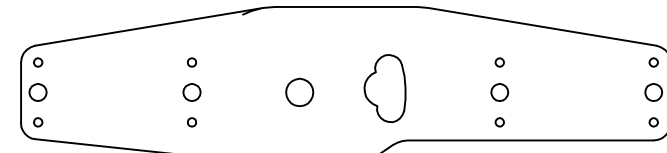

6A039A0D x 2

HOT AIR MIXER BOX COMPONENTS CARD JIT 22-2:

A- AE102/624- AS1072- 8 FIRESLEEVE

PQ0019N x 1 x 700

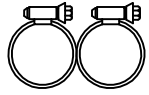

PV4A001N x 2

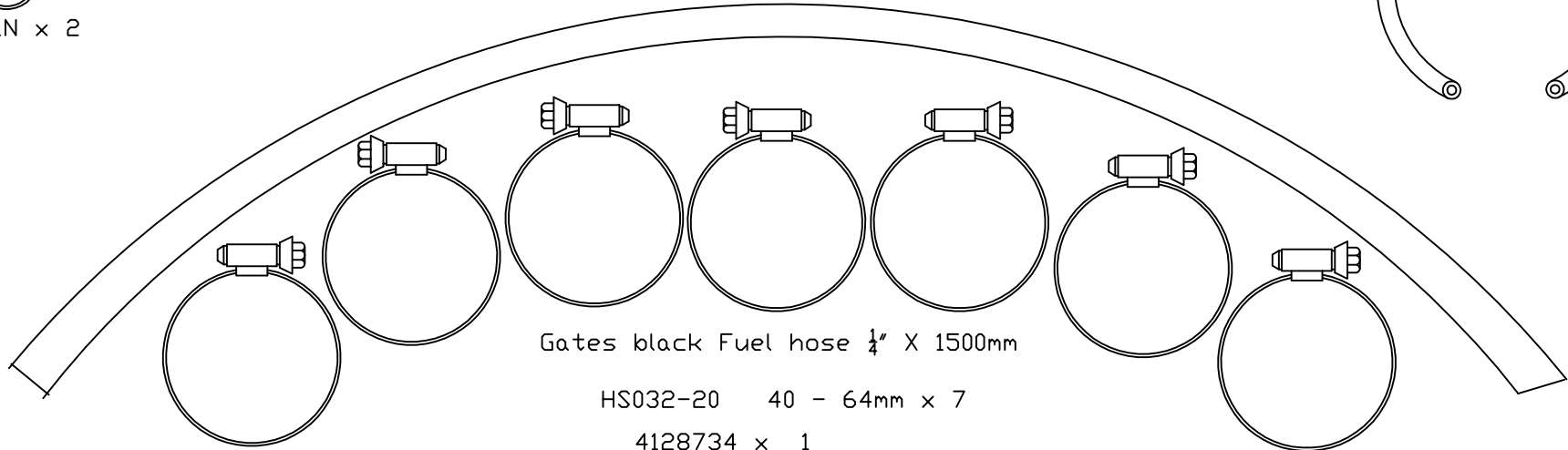
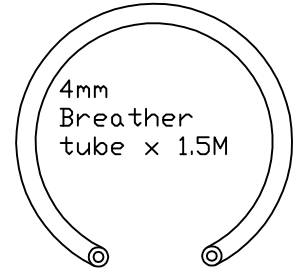

Gates black Fuel hose $\frac{1}{4}$ " X 1500mm

HS032-20 40 - 64mm x 7

4128734 x 1

2.25" SCATHOSE 1.4m

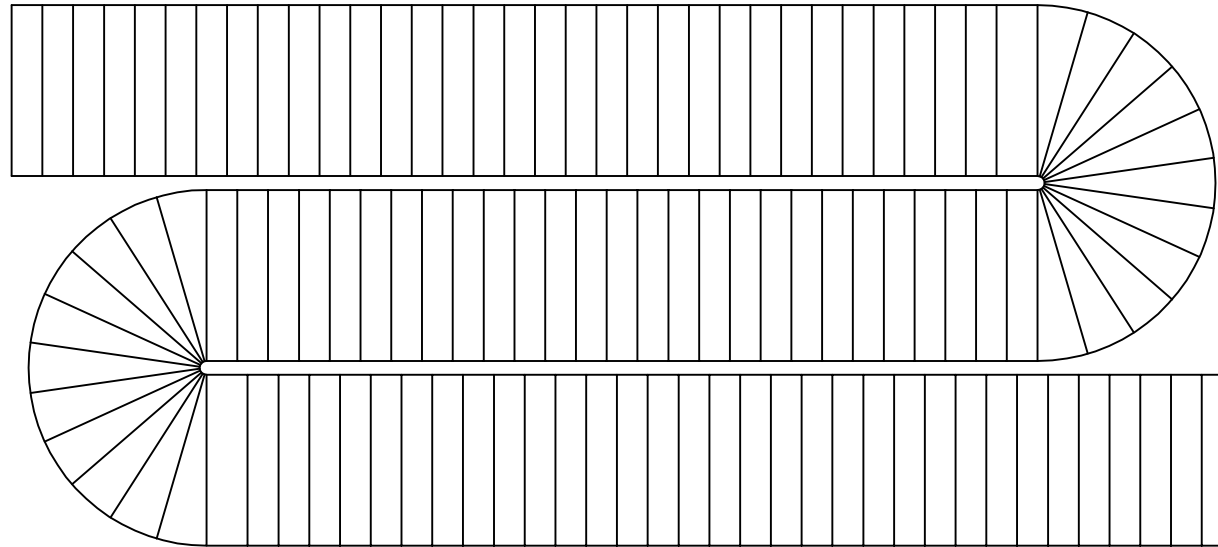

CARDJT 23-2: OIL BOTTLE, ENGINE, SPINNER HARDWARE

current as on 27-4-09

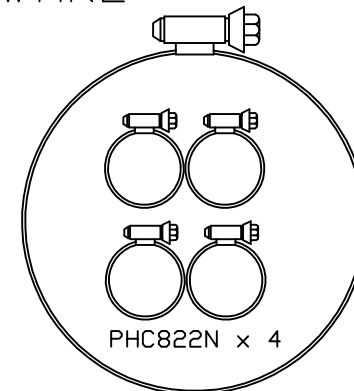
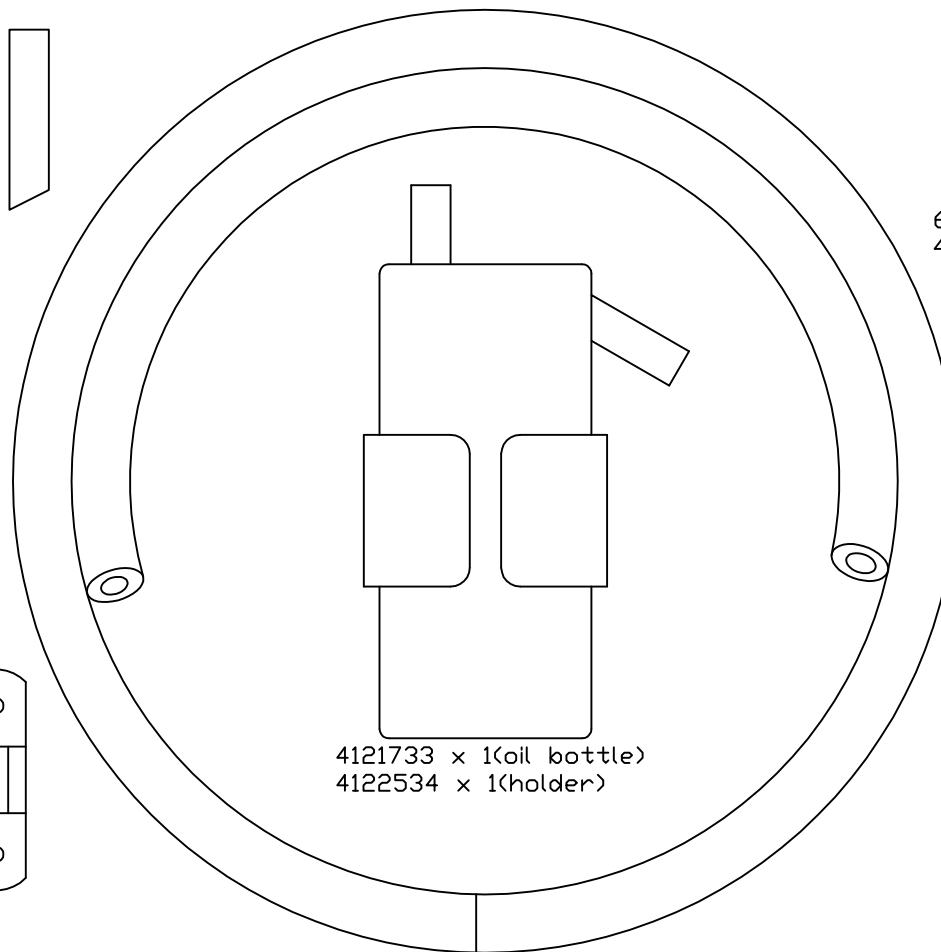
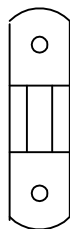
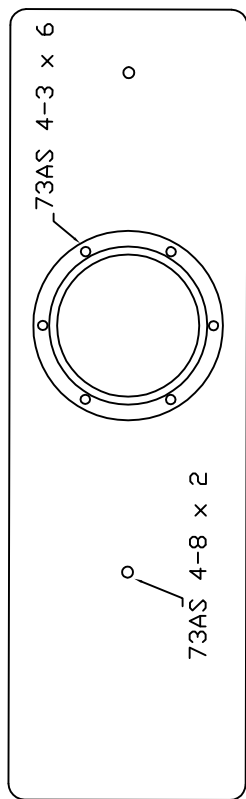

6 Cyl HS060 105-130mm x 2
4 Cyl PHC8408 x 2

8G x 1/2 P/H



8G x 1/2 CSK x2

1/2 inch Heater Hose (1400mm)

CARD JT 25-2: CABIN HEATER

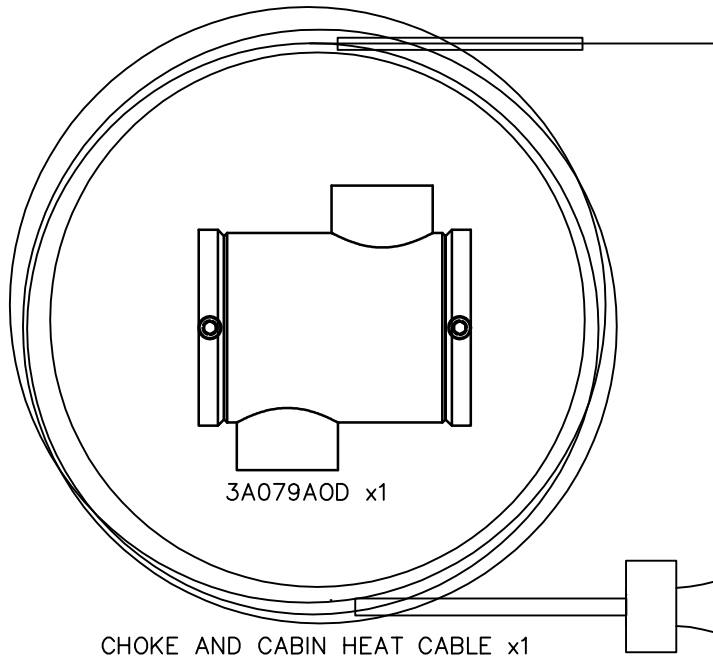

DESCRIPTION	QTY
PX00394 Spring	1
4615074 right angle bracket	1
4A454CON	1
AN316-5R 5/16halfnuts unc	2
AN960-416	1
3/32 x 3/4 ROLL PIN	1
AN380-1-6 Split Pin	1
73-AS-4-3 RIVET	1
M4 PLAIN NUT	1
M4 NYLOC NUT	1
32250045/16threaded sleeve	1
3/16x1/2UNC CAP SCREW	4
M4 x 25 PAN SCREW	2
MS35214-26	2
4A454BOD	1

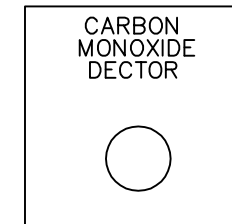
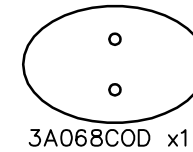
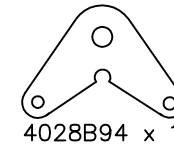
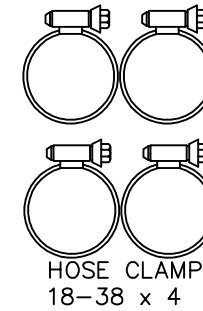
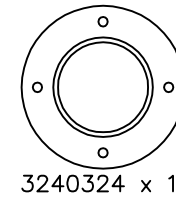

CARBON DECTOR x 1

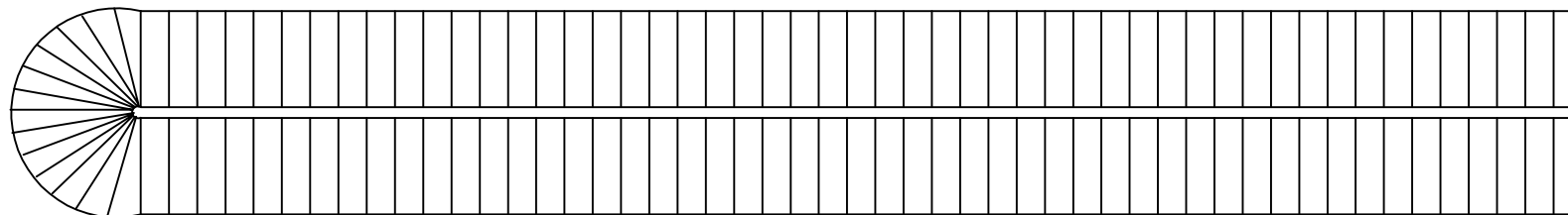
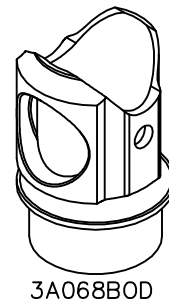
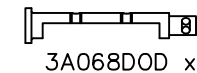

SCAT HOSE 1
1/4 x 1.5M

CARD J26: REAR SEAT HARDWARE current as on 24-4-09

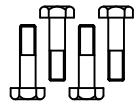

AN5-10A x 4

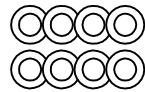

AN960-516 x 8

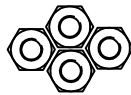

MS20365-524 x 4

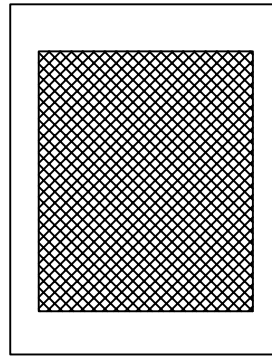

2" WIDE GLASS TAPE
2 x 3.2m, 2 x 1.65m



AN3-6A x 4



AN3-10A x 6

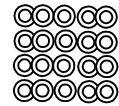

AN960-10 x 20



MS20365-1032
x 10

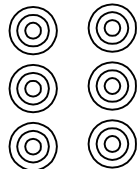

1109004 x 6

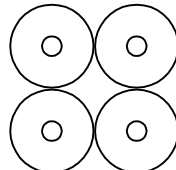

3042094 x 4

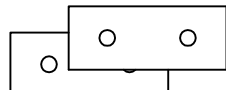

3128004 x 2

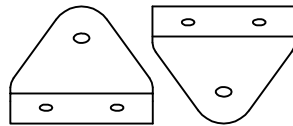

5000094 x 2

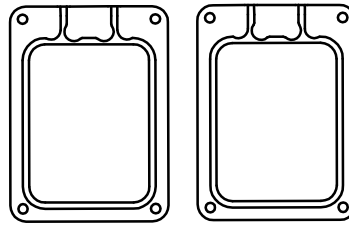

3A069B0D X 2

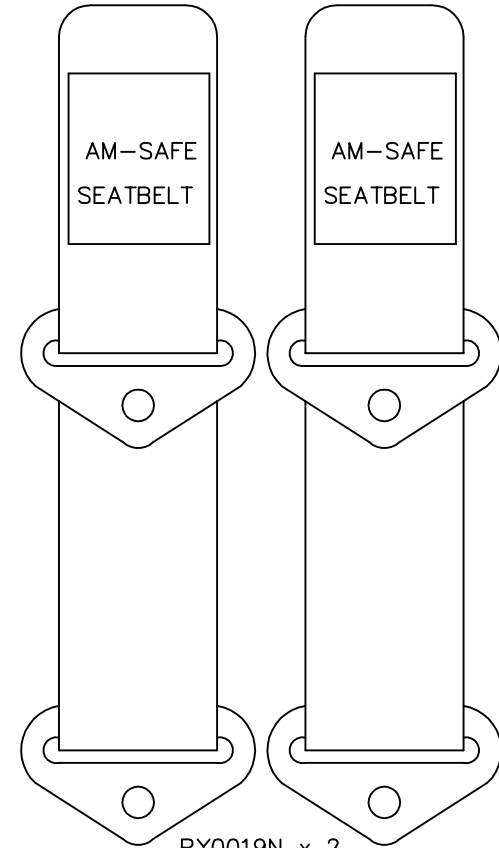

PY0019N x 2

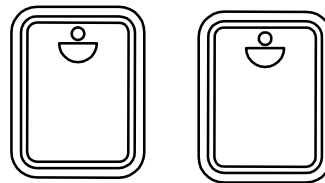

3A069C0D X 2

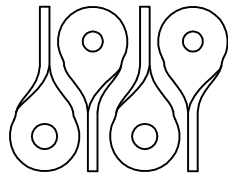

1108204 x 4

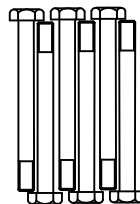

AN6-26A x 6

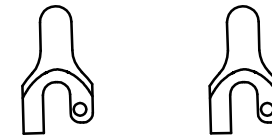

3A069D0D X 2

M4 NYLOC NUT X 2

M4 x 25Pan X 2 SCREW