

DOORS: CARD J1-3

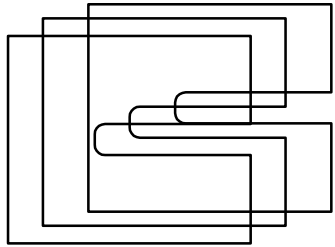

1A087A0D X 3

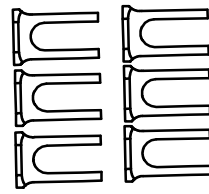

7A000B0D X 6 7A014B0D X 3

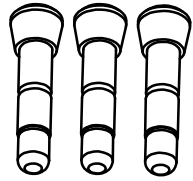
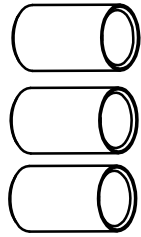

7A014C0D X 3

| |
|-----------------------------------|
| PH7A002N x6 3/16x3/4unc CapScrews |
| PH3A001N X 6 |
| MS24693S275 CSK x 6 |
| AN970-3 x 9 |
| BUNDY TUBE 8mm x 6 |
| MS24693S274 CSK x 6 |
| O-RINGS X 3 |
| CIRCLIPS X 3 |

O'RING BS204 X 3

PH9A010N
DOOR LATCH 3
PACK

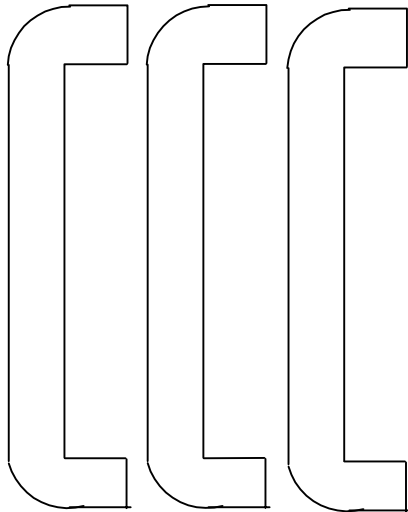

PM5A001N x 3

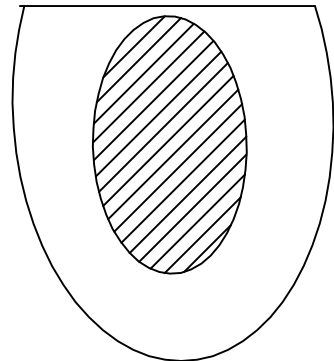
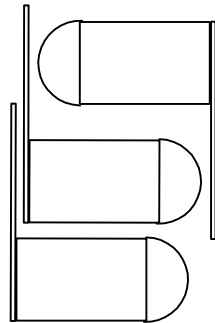

7A026A0N X 3

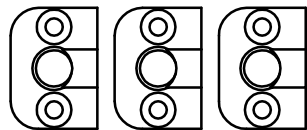

7030014 x 3

4.1m DOOR SEAL ATTACHED
4.1m WHITE DOOR SEAL

Door Strap X 1400mm

TRIM SYSTEM: CARD J2-3

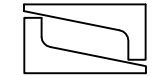
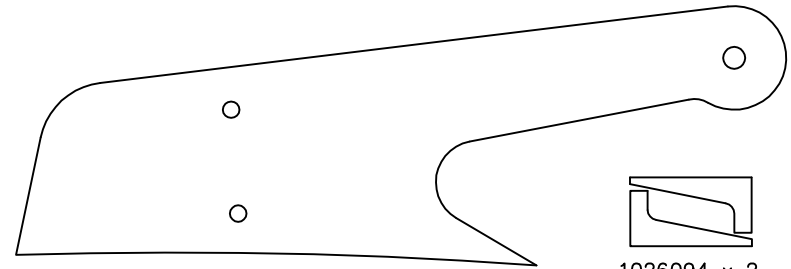

1026094 x 2

5009094 x 1

3A060C0D X 1
Alum Spacer

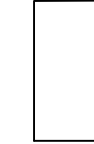

3065094 x 1

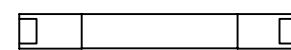

3A060D0D x 1

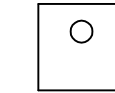

3061094 x 1



PB0078N x 2

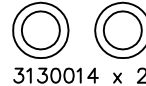

3130014 x 2

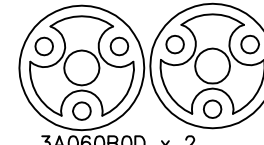

3A060B0D x 2



3129014 x 2

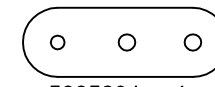

3063094 x 1



PX7A003N x 2

3131014 x 1

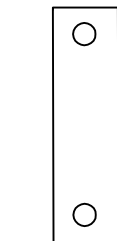

3A070A0D X 1
Fibre Glass



3102284 x 1

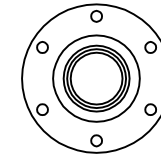

3103284 x 1

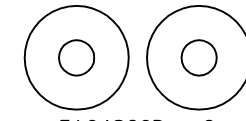

3A048C0D x 2
Friction Washers

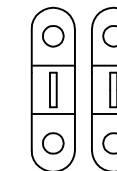

PC0289N x 2

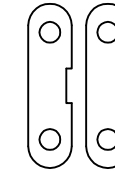

PC0299N x 2

| |
|------------------------------|
| AN3-35 x 1 |
| AN310C-3 x 1 castle Nut 3/16 |
| AN960-416 x 1 |
| AN3-10A x 1 |
| MS20365-1032 x 1 |
| PB0009N 3/16 ROD END x 1 |
| AN380-2-2 x 3 |
| AN970-3 x 1 Penny Washer |
| AN380-1-2 X 1 |
| Bundy Tube 21mm x 1 |

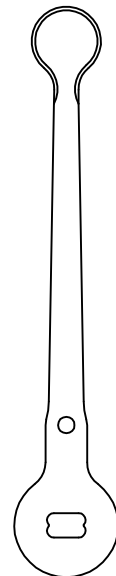
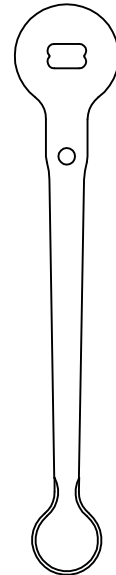

3A060E0D x 2

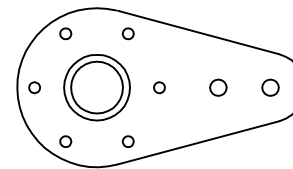

3103184 x 1



5A031A0D x 1

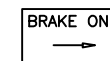

5A031B0D x 1

5061054 x 1 (VHF Aerial)

current as on 06-04-09

CARD J3-4: RUDDER

3A084B0D x1

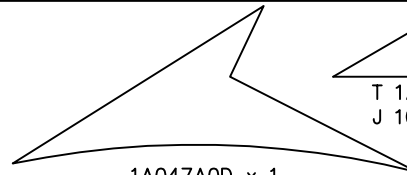
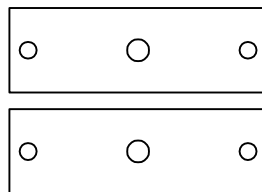
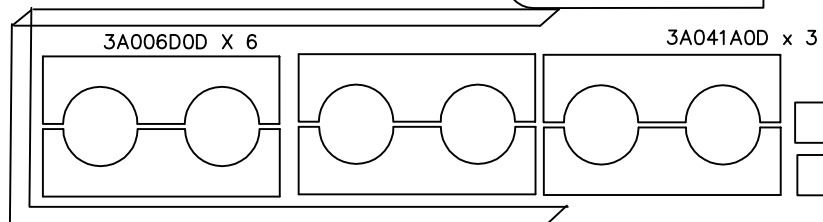

T 1A046A0D x 1
J 1023094 x 1

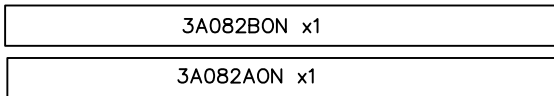

| HARDWARE LIST | |
|---------------|----------------------|
| PH115434 | x 2 CAP SCREW |
| PH0239N | x 6 (1/4 PLAIN NUTS) |
| AN4-23A | x 1 |
| AN3-23A | x 2 |
| AN3-25A | x 4 |
| AN4-14A | x 2 |
| AN4-25A | x 3 |

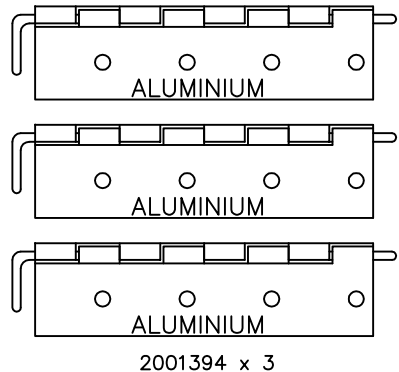
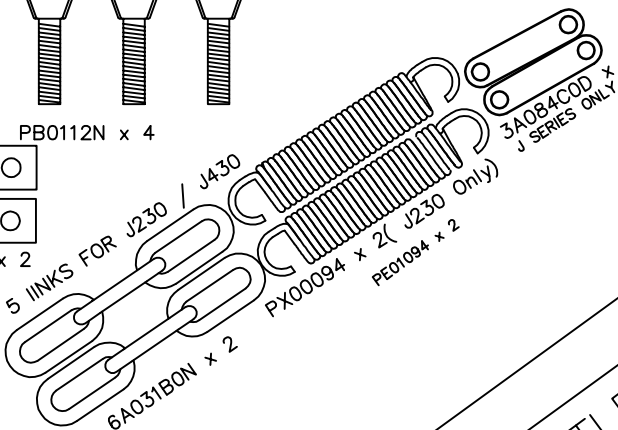
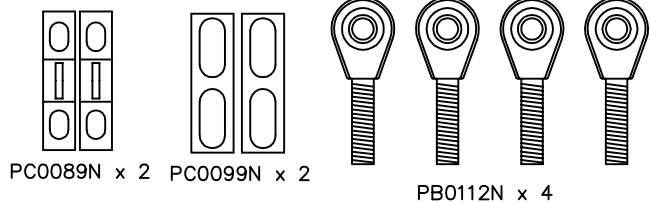

3A005C0D x 1 OR 3A005C1D x 1 (Jumbo)

STANDARD COMPONENTS

JUMBO

3A005E0D x 2

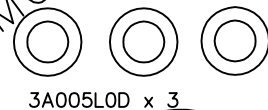
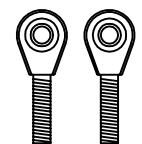
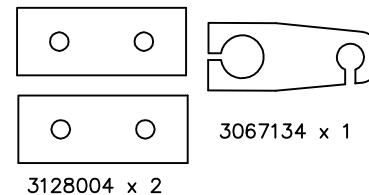
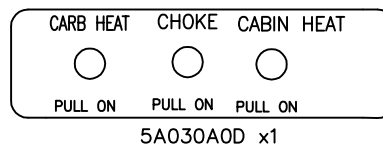
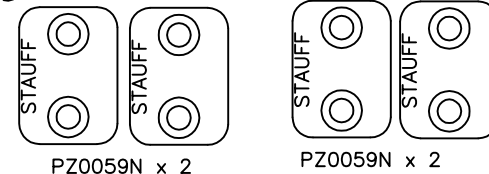
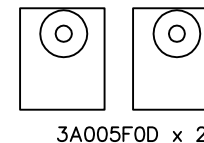

3A005B0D x 2

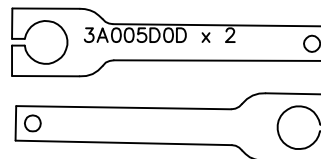

| HARDWARE LIST | |
|---------------|------------------|
| AN3-22A | x 2 |
| AN380 2-2 | x 1 Split pin |
| PH0778N | x 3 GRUB SCREW |
| 3/8 x 1 3/4" | BRASS SCREWS x 4 |
| AN4-13A | x 2 |
| AN970-3 | x 2 PENNY WASHER |
| AN3-11A | x 5 |
| Bundy Tube | 17mm x 2 |

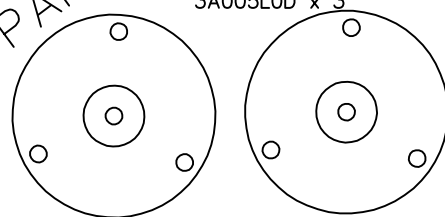

CARD J4-4: PANEL MOUNT THROTTLE

CARD **JIT** 5-3: AILERON SYSTEM current as on 27-4-09

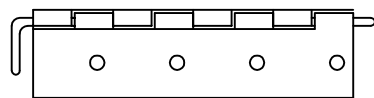
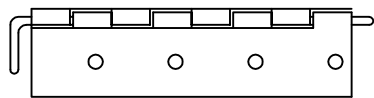
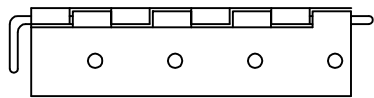
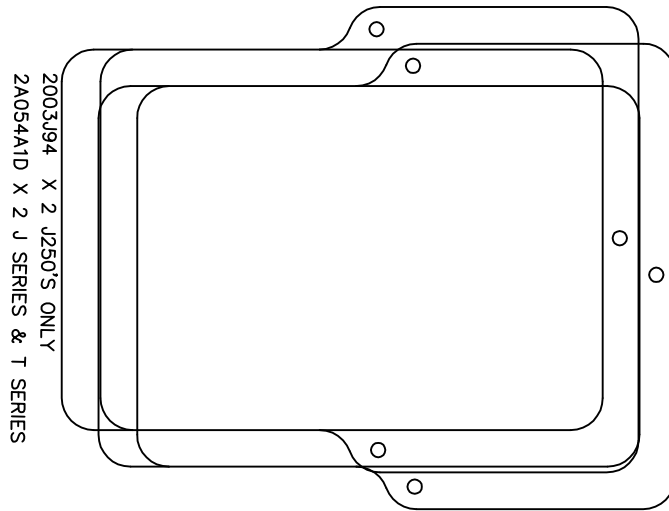

ALUMINIUM

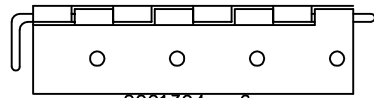

2001394 x 6

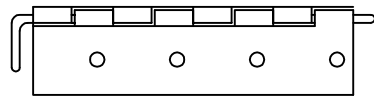

2A080G0D X 12
(only 8 for J170)

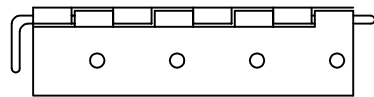

Long Aileron x 6



2A080C0D X 12
(only 8 for J170)

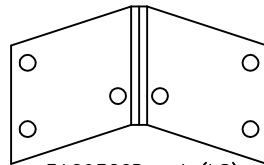

3A093C0D x 1 (LS)
3A093D0N x 1 (RS)



3115094 x 2



PC0089N x 2



PC0099N x 2

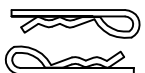

PH0259N R CLIP x 2

CARD **JIT** 6-2: STALL WARNING current as on 27-4-09

PV0029N x 1
8mm Clear Tube x 1800mm

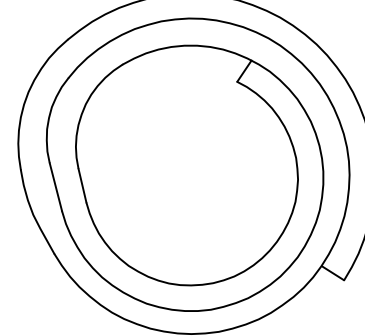

VELCRO (HOOKS ONLY) X 400MM



2082014 x 1



2061294 x 1



2061394 x 1

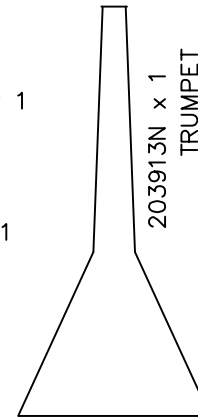

203913N x 1
TRUMPET

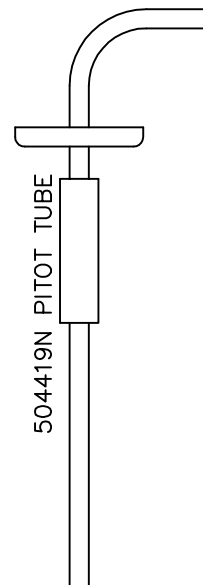

504419N PITOT TUBE

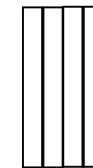

5102094 x 4
STATIC LINE JOINERS 50 mm

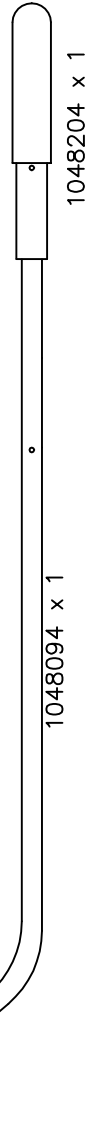

1048204 x 1

1048094 x 1

CARD J7-3: UNDERCARRIAGE

current as on 24-4-09

| J DESCRIPTION | QTY |
|---------------|-----|
| AN3-11A | 2 |
| AN4-22A | 2 |
| AN4-25A | 2 |
| AN6-32 2 SEAT | 2 |
| AN6-27 2 SEAT | 2 |
| AN6-31 2 SEAT | 2 |

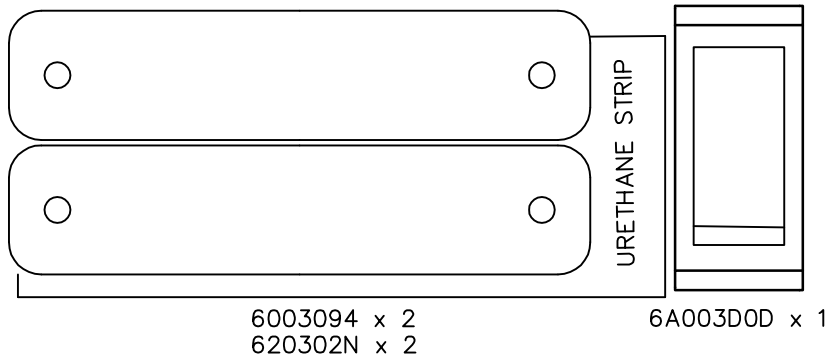
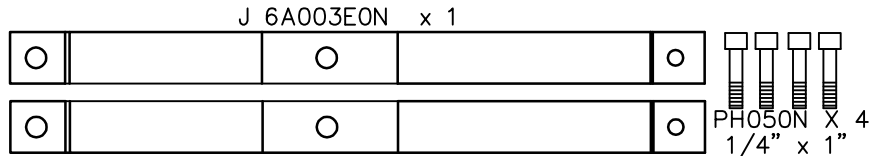
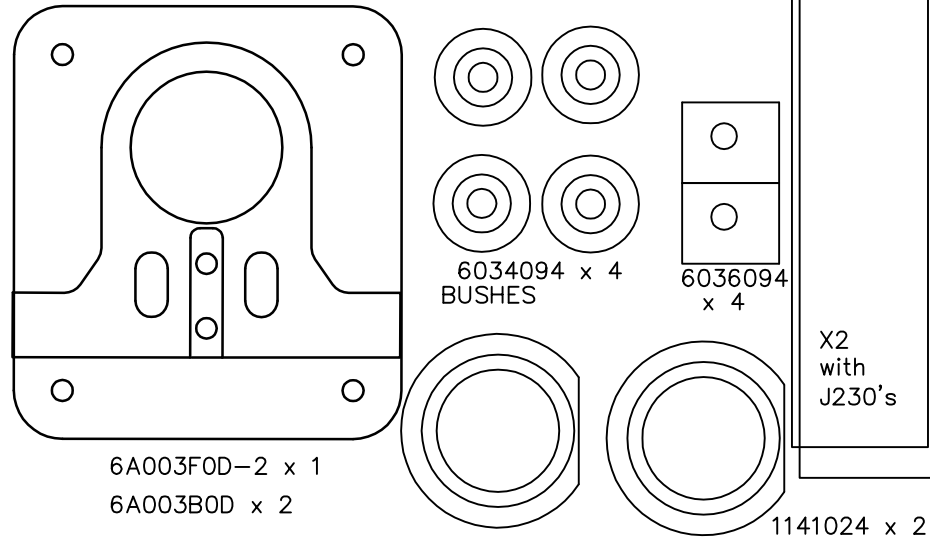
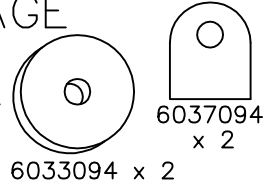

CARD J7-3: UNDERCARRIAGE

current as on 24-4-09

| J DESCRIPTION | QTY |
|---------------|-----|
| AN3-11A | 2 |
| AN4-22A | 2 |
| AN4-25A | 2 |
| AN6-32 2 SEAT | 2 |
| AN6-27 2 SEAT | 2 |
| AN6-31 2 SEAT | 2 |

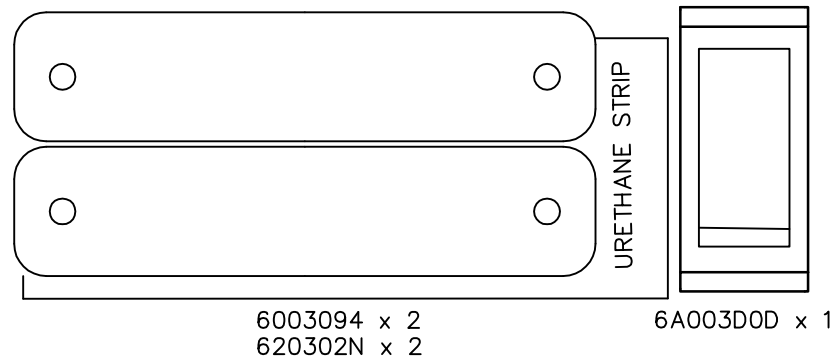
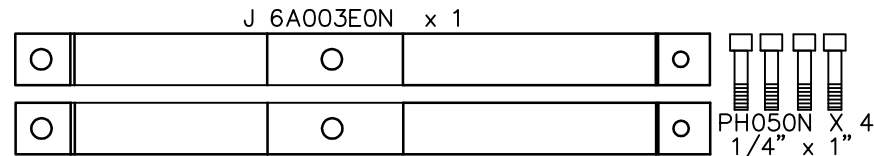
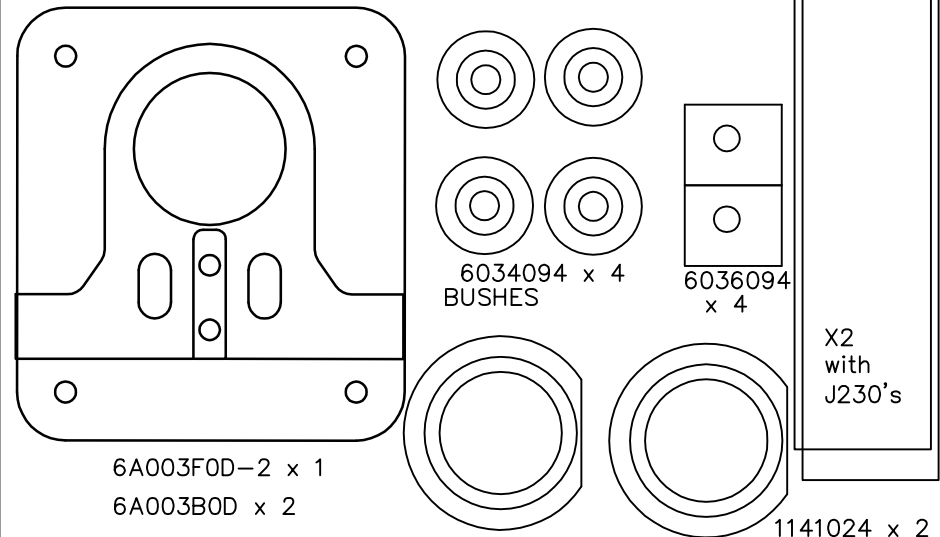
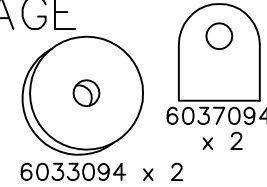

CARD J8-2 : DUAL BRAKES

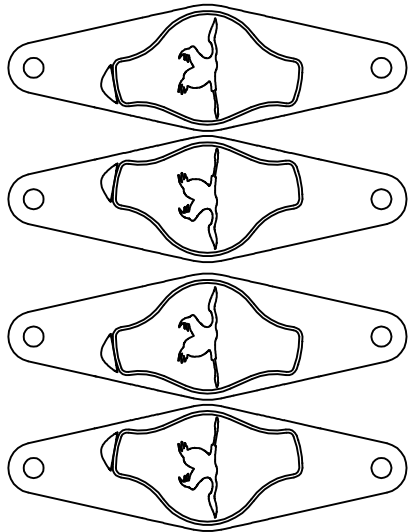

620762N x 2(LH)
6207124 x 2 (RH)

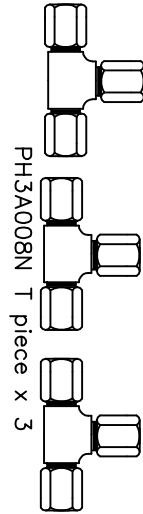

PH3A008N T piece x 3



6207224 x 4
BRAKE PISTON
BREAK HOSE X
3.5M

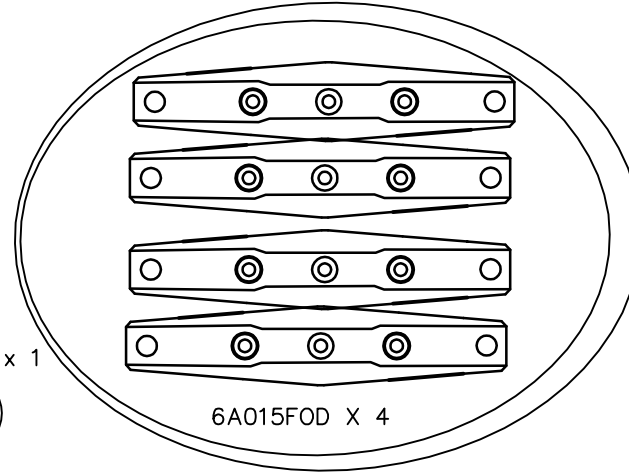

6A015FOD X 4

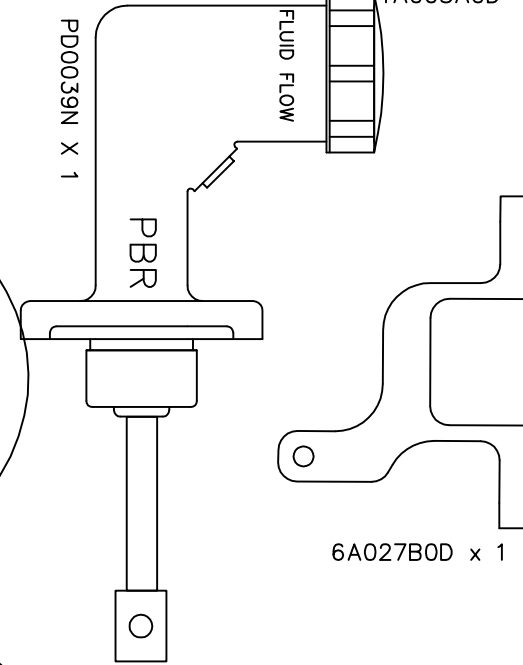

Brake Lever Stop
cover x 1
1A003A0D

6A027B0D x 1

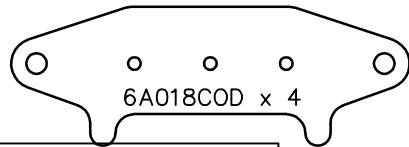

6A018COD x 4

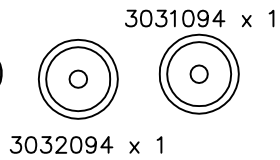

3031094 x 1

3032094 x 1

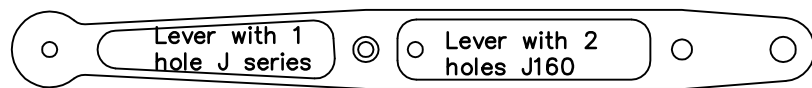

6A027C0D X 1

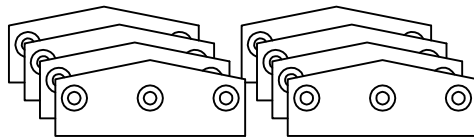

6000994 x 8

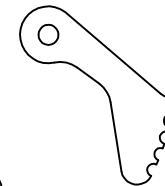

3060094 x 1

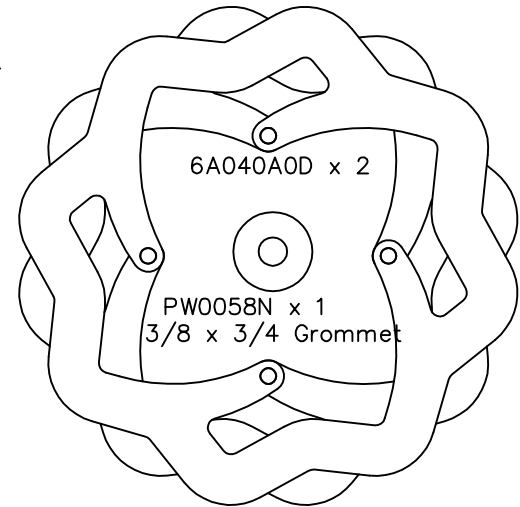

6A040A0D x 2

PW0058N x 1
3/8 x 3/4 Grommet

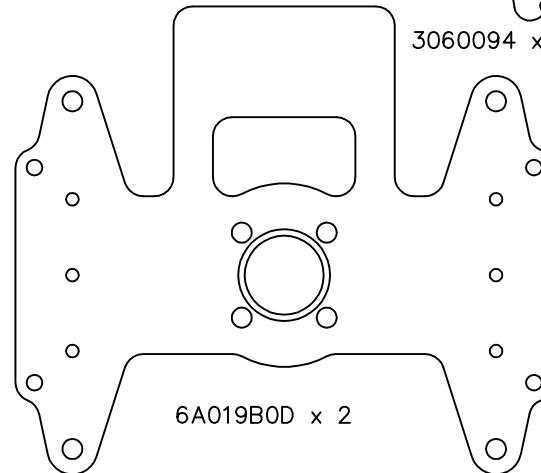

6A019B0D x 2

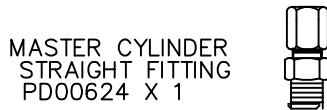

MASTER CYLINDER
STRAIGHT FITTING
PD00624 X 1

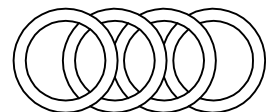

BS0214 x 4 O-RINGS

| SMALL PARTS |
|-----------------------------------|
| 1/4 unc 1" cap X2 |
| AZ2-03 x 4 BRAKE CYLINDER FITTING |
| 6100094-3 x 4 |
| PH1200N X 14 BRAKE RIVETS |
| PX0029N X 8 BRAKE SPRINGS |
| 3/16" FERRULE x 4 |
| AN380-2-2 x1 Split pin |
| 3/16 BSW 1 1/2" x 1 |
| 1/4 unc X 3/8 capX2 |
| AN4-15A x 8 |
| MS21045-4 x 8 |
| AN960-416 x 8 |
| AN5-10A x 1 |
| AN4-11A X 1 |
| PH1190N X 14 BRAKE RIVETS |

CARD J9-2: SEATBELTS

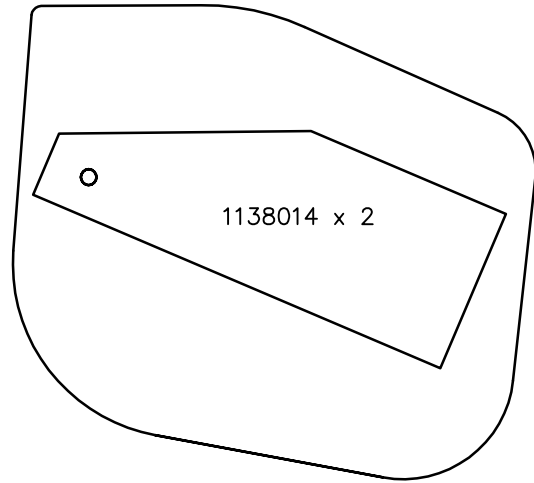

1138014 x 2

1142024 x 2

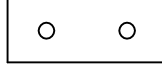

3128004 x 4



1109004 x 6

1A002A0D x 2

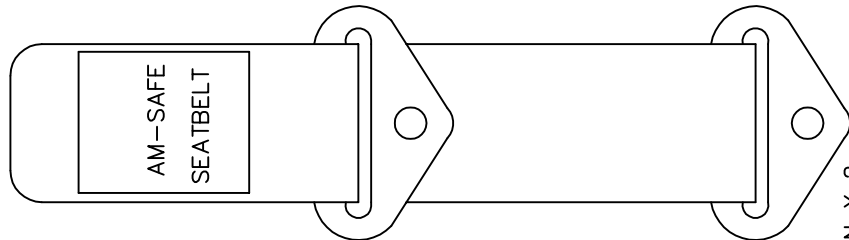

PY6019N X 2

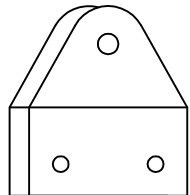
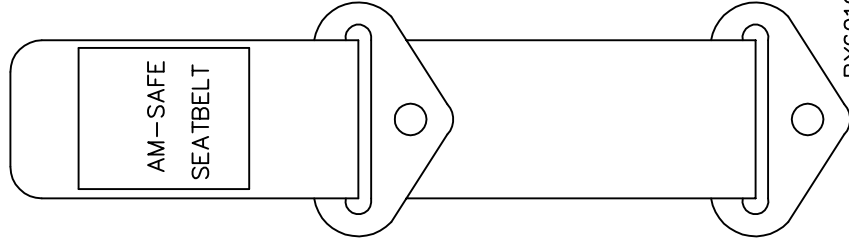

5001094 x 2

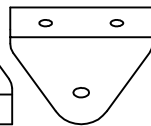
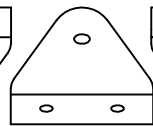
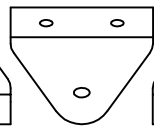
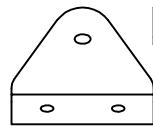

5000094 x 4

CARD J10-2: FIREWALL

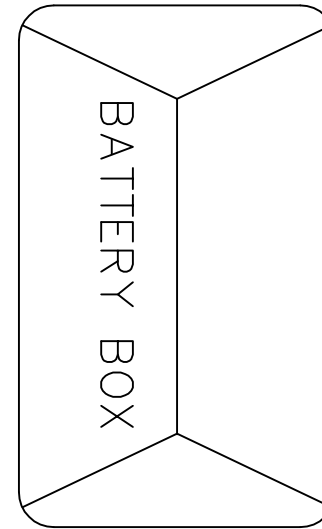

5040094 x 1

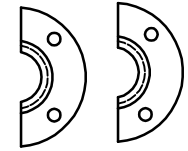

1A071B0D X 4



8-22 HOSE CLAMPS X 2



1042094 x 1



PW0069N x 2
1/2 inch Grommet

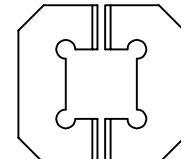

5037094 x 2



PW0009N x 2
1 1/8 inch Grommet

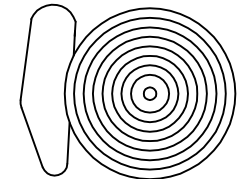

PH9916N x 1

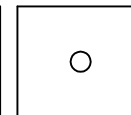
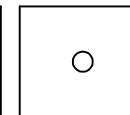
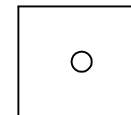
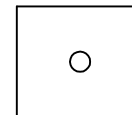

4025094 x 4

CARD J11-3: FUEL COMPONENTS CFI

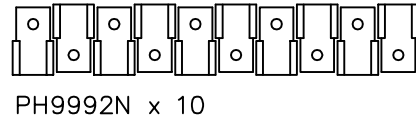
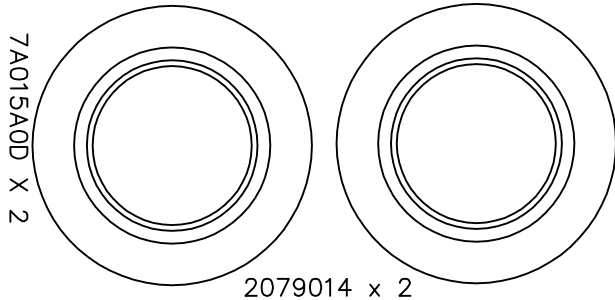

PM0029N x 1

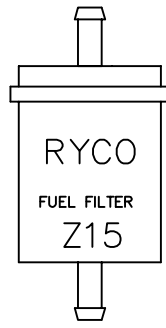
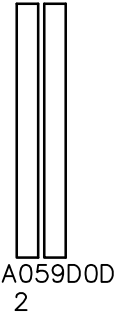
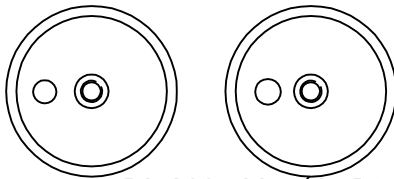
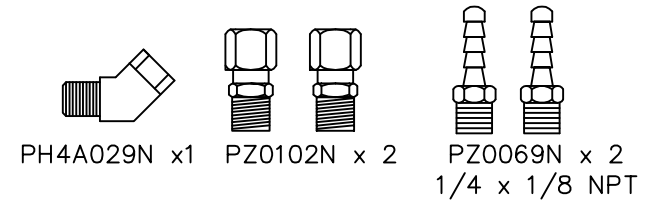

PM0009N x 1

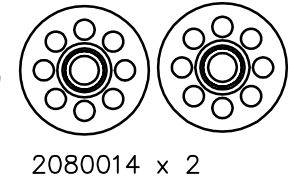
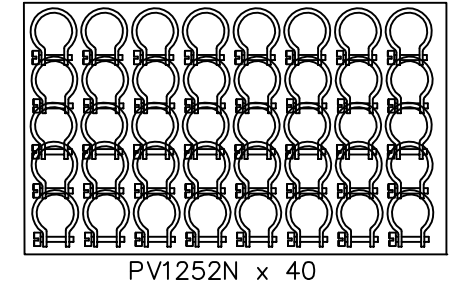
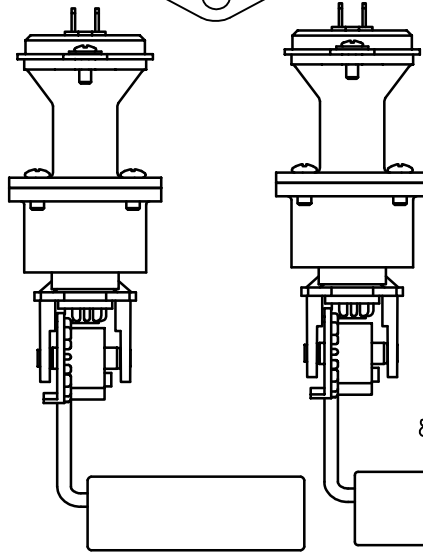

8G 3/4 PAN x 2

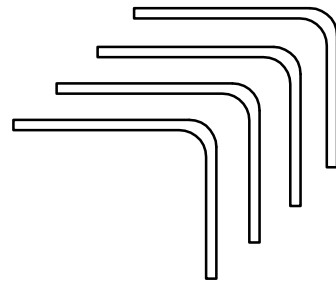
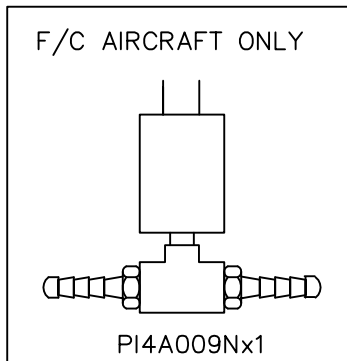
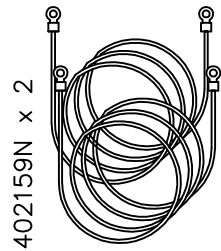

3/16 ALLEN KEY x 1

4A278A0D-1 x 2

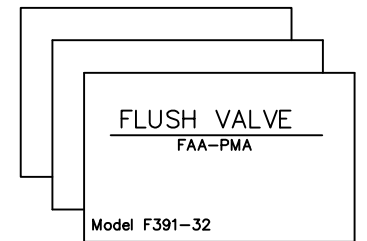

PM0049N x 3

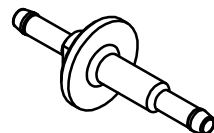
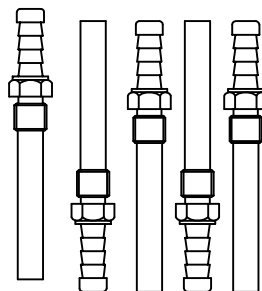

4A295B0D BULKHEAD X1

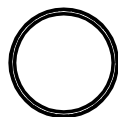

4A281C0D SLEEVE X1

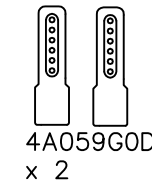
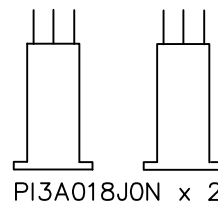
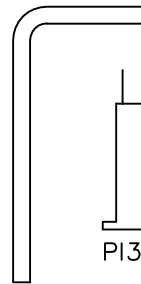

PH4A025N x 2

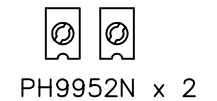
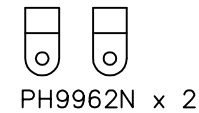

PZ4A005A0N x 2

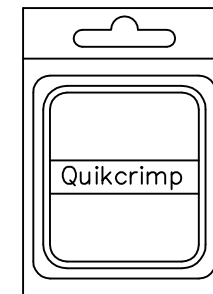

PHQK2N x 1

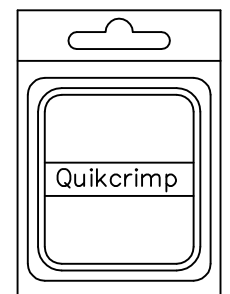

PHQK4N x 1

Electrical Connector Electrical Connector

CARD J12-2: FUSELAGE TRIMMINGS

Current as on
14-5-09

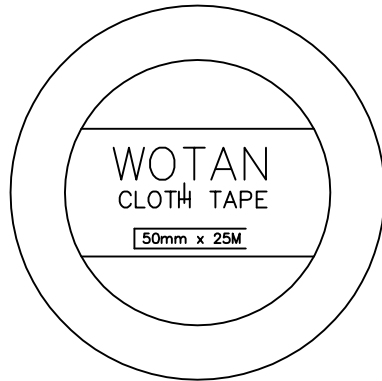

2003093 x 1

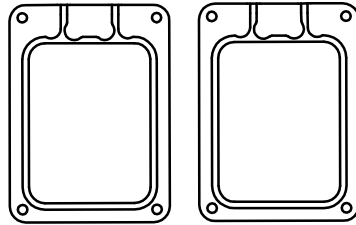

3A069B0D X 2

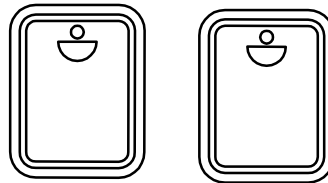

3A069C0D X 2



3A069D0D X 2

| HARDWARE |
|----------------------|
| M4 NYLOC NUT X 2 |
| M4 x 25Pan X 2 SCREW |
| PH9H006 X 2 SCREWS |

CARD J13-2: COWL COMPONENTS

Current as on
14-5-09

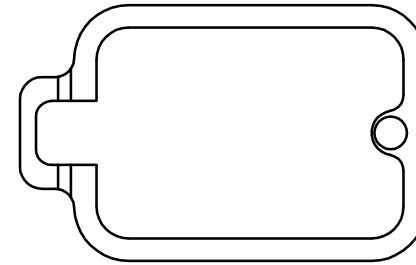

1A081B0D X 1

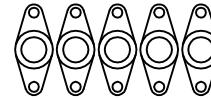

212-12D x 5



2600-6 x 2



2600-8x 3

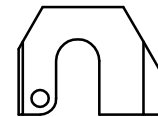

1A081E0D X 1

| HARDWARE |
|---------------------|
| PM5A003N X 1 MAGNET |
| PH9H006 X 2 SCREWS |
| COTTER PIN X 1 |

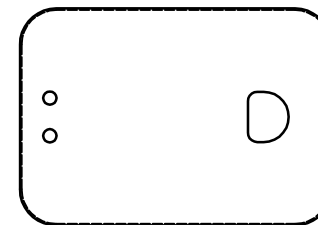

1A081D0D X 1

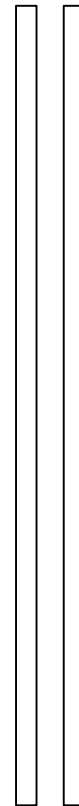

1/4" ALUMINIUM TUBE
x 2 (28cm)

Card JIT 14-2: OPTION 1 & 2 HARDWARE CFI

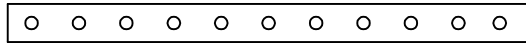

5019094 x 1

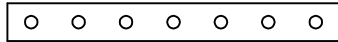

502009N x 1

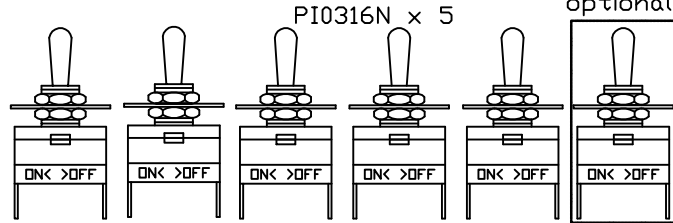

PI3A005A0N X 1
LED PANEL GREEN

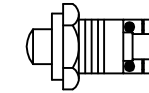

PI0170N x 1
PI0169N x 1
(ALT)

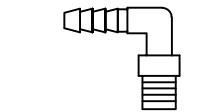

PI3A004A0N X 2
LED PANEL RED

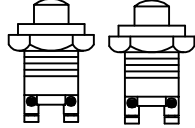

PI0172N x 2
A.S.I

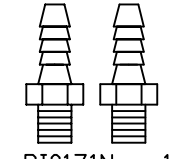
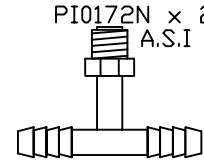

PI0171N x 1
(ALT)

| DESCRIPTION | QTY |
|-------------------------|-----|
| AN960-10-Full Washer | 13 |
| PI3A019A0N isolators | 2 |
| MS21069-L08 RETAINERS | 8 |
| MS21045-3 | 5 |
| PH3A009N M3 X 8 PAN | 10 |
| AN3 12A | 5 |
| MS35206-245 | 8 |
| TAPK 3-3 Rivet | 16 |
| MS21044B06 Campuss Nut | 8 |
| 5/32 BRASS WASHER | 3 |
| 5105004 threaded washer | 5 |
| PH0419N M4x12PH Screw | 30 |
| M4 NYLOC NUTS | 30 |
| MS35214-30 Black Screws | 17 |
| MS3373-16C Alien Nut | 14 |
| PW0058N Grommet | 5 |
| MS35214-26 Black Screws | 30 |

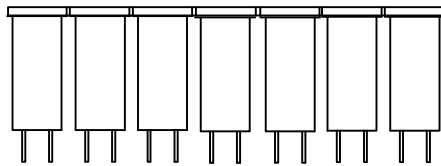

15A Circuit Breaker x1
10A Circuit Breaker x2
5A Circuit Breaker x4

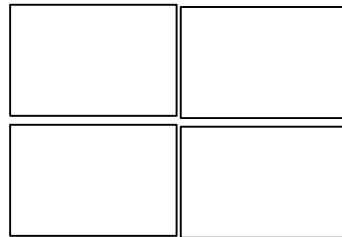

PI4A01N x 2
Suppressor

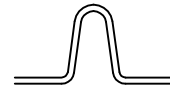

PV4A003N X 1

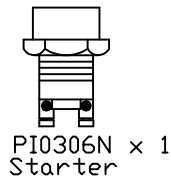
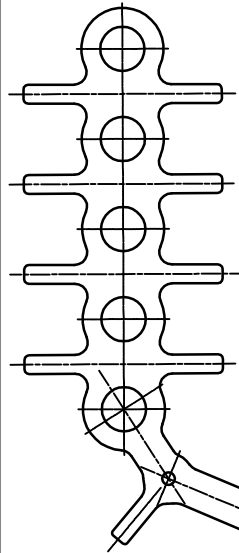

PI0306N x 1
Starter

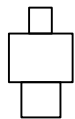

Female BNCx1
2164514 crimp
type

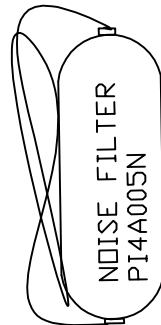

NOISE FILTER
PI4A005N

Electrical List:

- Red Spade Female X 110
- Blue Spade Female X 12
- Yellow Spade Female X 16
- Red Spade Male X 10
- Red Ring 4mm X 20
- Red Ring 6mm X 4
- Blue Ring 4mm x 3
- Blue Ring 5mm X 2
- Blue Ring 8mm X 1
- Yellow Ring 5mm X 7
- Yellow Ring 6mm X 5
- Yellow Ring 8mm X 5

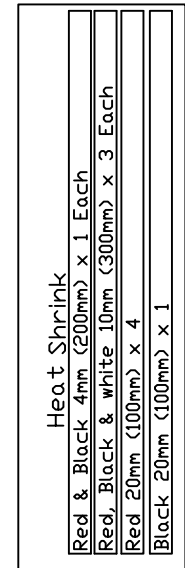
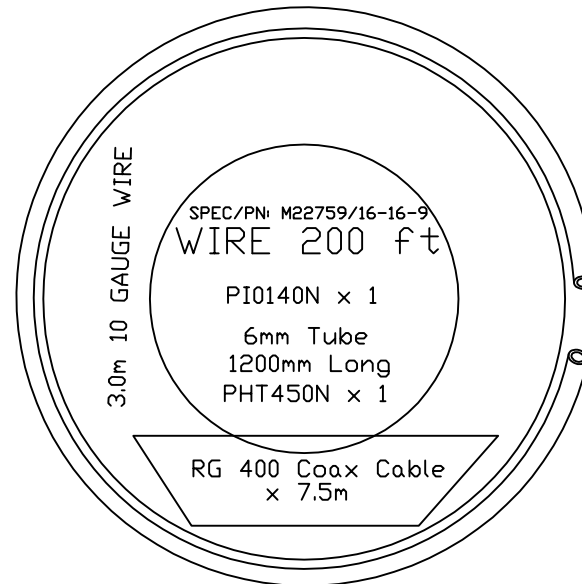

5A020E0D X 1

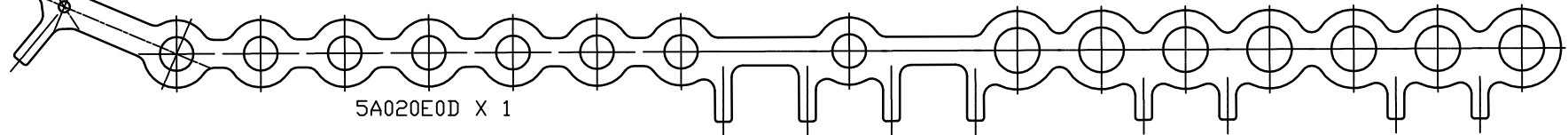

Card J17 14-3: OPTION 3&4 HARDWARE

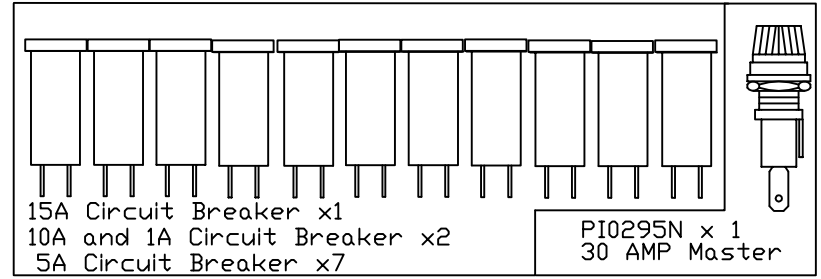
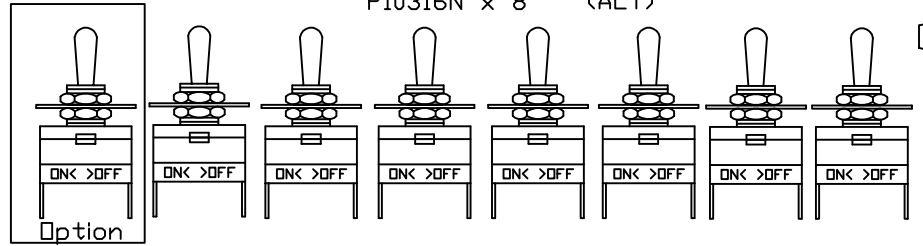
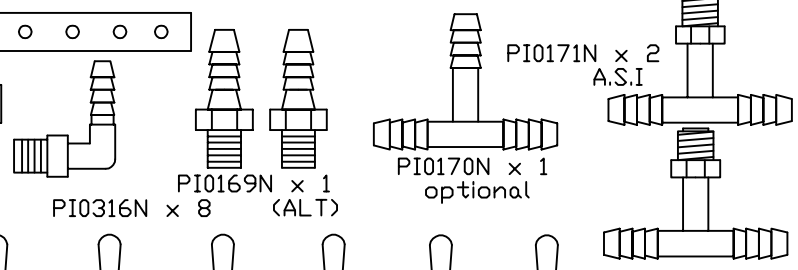
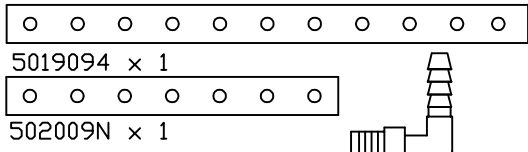

Electrical List:

| | |
|--------------------------|----|
| Red Spade Female X 110 | 7 |
| Blue Spade Female X 12 | 13 |
| Yellow Spade Female X 16 | 2 |
| Red Bullet Male X 1 | 8 |
| Red Spade Male X 10 | 7 |
| Red Ring 4mm X 20 | 7 |
| Red Ring 6mm X 4 | 7 |
| Blue Ring 4mm x 3 | 8 |
| Blue Ring 5mm X 2 | 3 |
| Blue Ring 8mm X 1 | 3 |
| Yellow Ring 5mm X 7 | 3 |
| Yellow Ring 6mm X 5 | 14 |
| Yellow Ring 8mm X 5 | 10 |

| DESCRIPTION | QTY |
|-------------------------|-----|
| PW0058N Grommets | 7 |
| AN960-10-Full Washer | 13 |
| PI3A019A0N | 2 |
| MS21069-L08 RETAINERS | 8 |
| MS21045-3 | 7 |
| 5105004 Threaded Washer | 7 |
| AN3 12A | 7 |
| MS35206-245 | 8 |
| MS35214-29 | 3 |
| MS21044B06 | 3 |
| 5/32 BRASS WASHER | 3 |
| TAPK 3-3 | 16 |
| M4 x 12 PH | 30 |
| M4 NYLOC NUTS | 30 |
| MS35214-31 Screws | 14 |
| MS3373-16CNuts | 14 |
| PH3A009N M3 X 8 PAN | 10 |

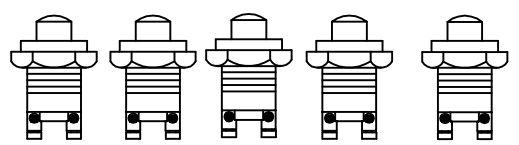
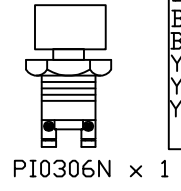

Female BNCx1
2164514 crimp
type

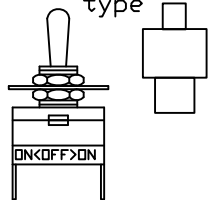

Landing Light
switch(NVFR)



5A043H0D - 3PIECE
BUS BAR

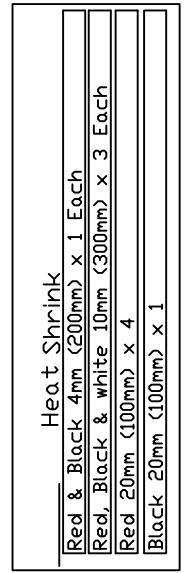
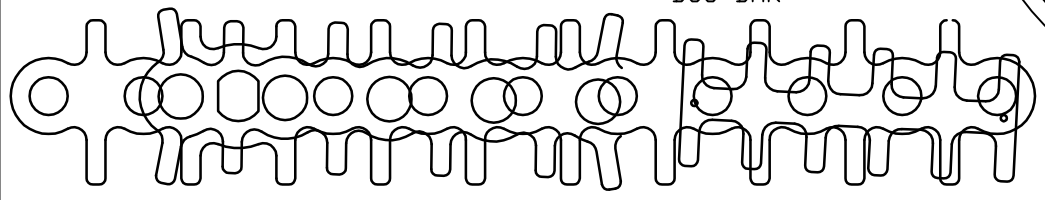
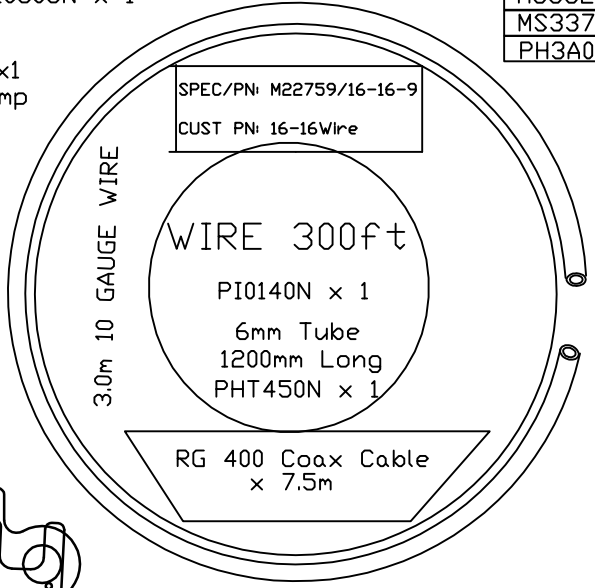

Card JIT 14-3: OPTION 5 HARDWARE

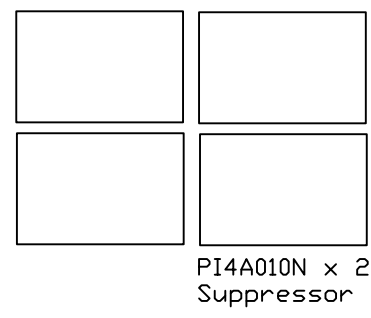
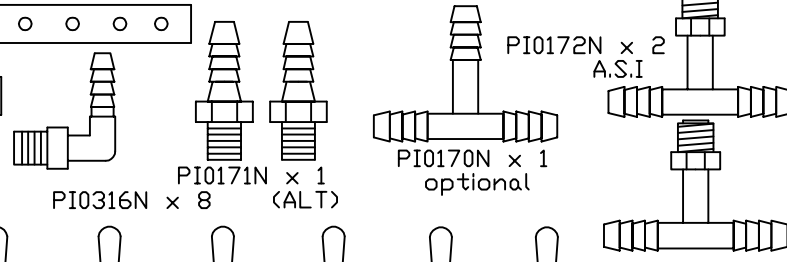
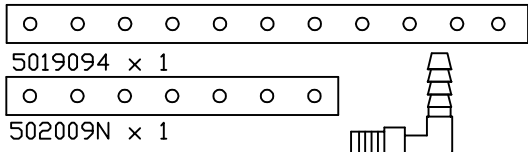

INSTRUMENT DIMMER COMPONENTS PACK

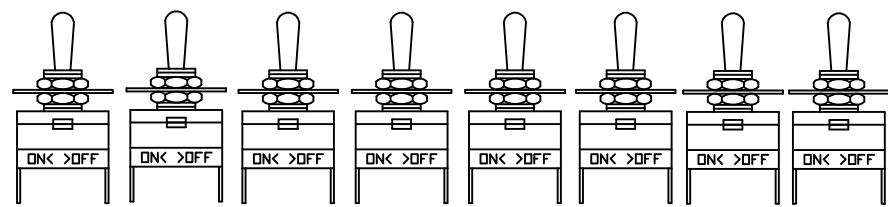

Electrical List:

- Red Spade Female X 110
- Blue Spade Female X 12
- Yellow Spade Female X 16
- Red Bullet Male X 1
- Red Spade Male X 10
- Red Ring 4mm X 20
- Red Ring 6mm X 4
- Blue Ring 4mm x 3
- Blue Ring 5mm X 2
- Blue Ring 8mm X 1
- Yellow Ring 5mm X 7
- Yellow Ring 6mm X 5
- Yellow Ring 8mm X 5

| DESCRIPTION | QTY |
|-------------------------|-----|
| PW0058N Grommets | 7 |
| AN960-10-Full Washer | 13 |
| PI3A019A0N ISOLATORS | 2 |
| MS21069-L08 RETAINERS | 8 |
| MS21045-3 HEAT NUTS | 7 |
| 5105004 Threaded Washer | 7 |
| AN3 12A | 7 |
| MS35206-245 SCREWS | 8 |
| MS35214-29 | 3 |
| MS21044B06 | 3 |
| 5/32 BRASS WASHER | 3 |
| TAPK 3-3 | 16 |
| M4 x 12 PH | 30 |
| M4 NYLOC NUTS | 30 |
| MS35214-31 Screws | 14 |
| MS3373-16CNuts | 14 |
| PH3A009N M3 X 8 PAN | 10 |

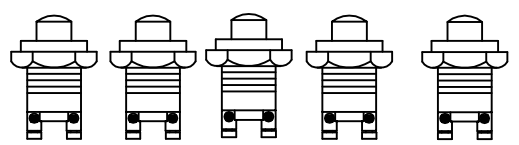
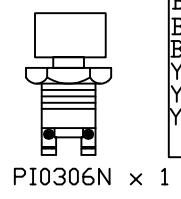
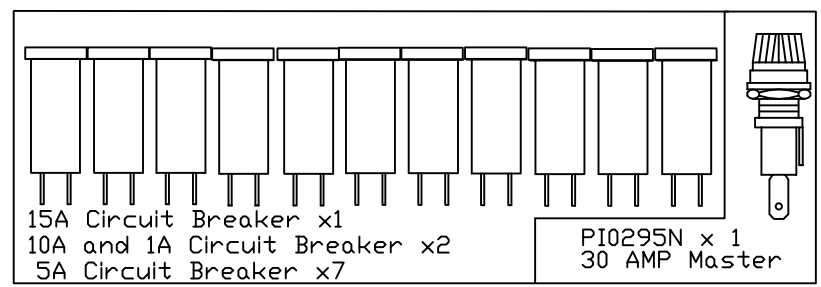

Female BNCx1 2164514 crimp type

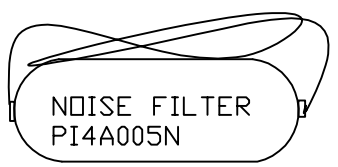
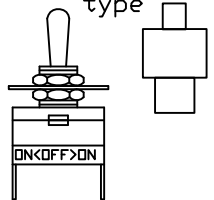

5A043H0D - 3PIECE BUS BAR

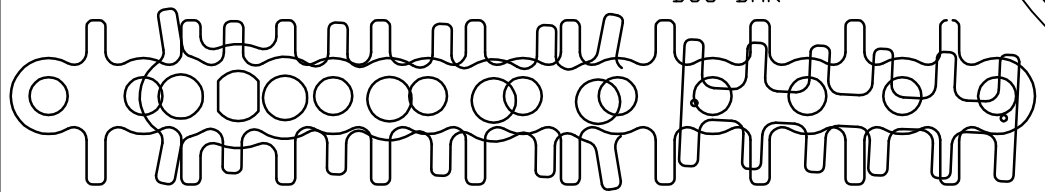
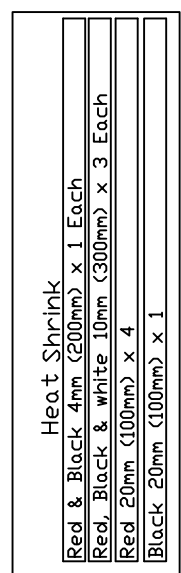
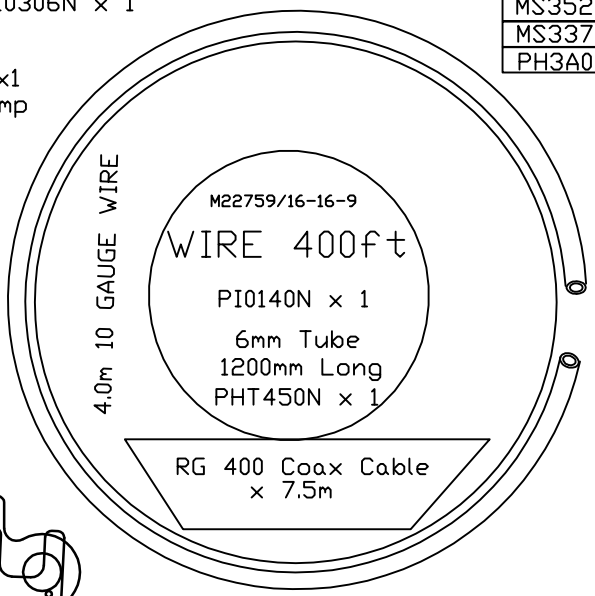

CARD J15B-2: SPARES CFI

Bundy Tube 1 to 6mm x 1
 Bundy Tube 10mm x 4
 Bundy Tube 19mm x 1

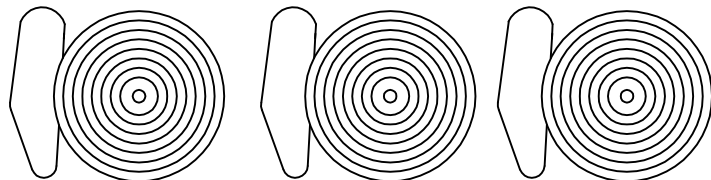

PH9916N x 3

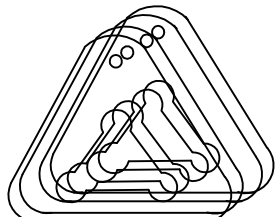

4009094 x 4
 PH4A032N X 10
 SPRINGS

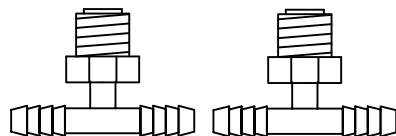

PI13190N X 2 Blue Water
 Traps



2A052A0D X 2



AN5-10A X 2

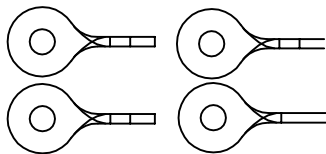
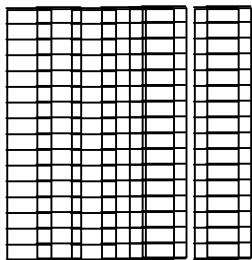

110824 X 4

Bullet Terminal x 1



Cigarette
 Lighter X 1
 Red Bullet x 1

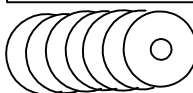
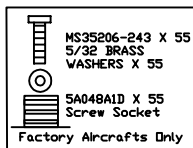

970-4 washers x 7
 4MM CLEAR TUBE X0.5M

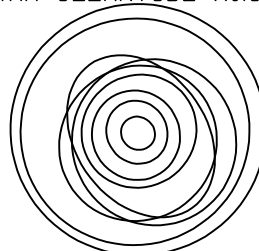

FUEL LINE SHEATING X 4.3M

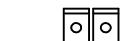

4615074 X 2

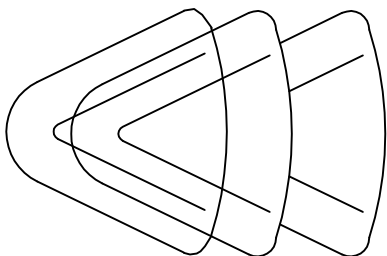

1037094 x 3
 AIR SCOOPS

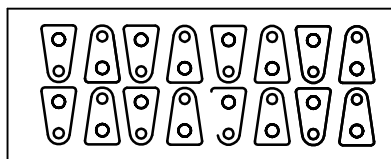

2001594 X 1

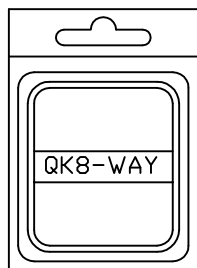

QK8-WAY X1

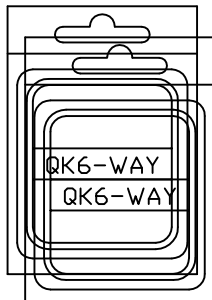

QK6-WAY X2

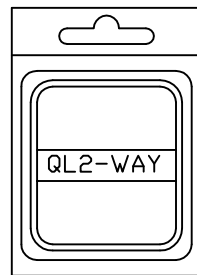

QL2-WAY X1

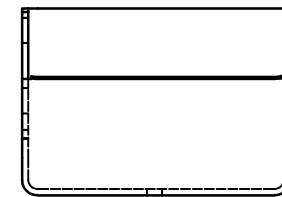

4984124 x 1
 Drip Tray

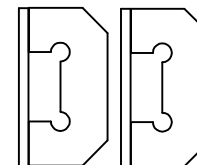

5037094 X 2

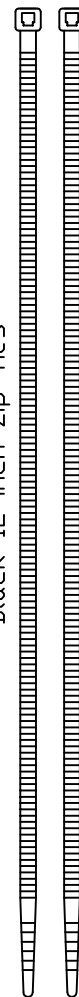

PH0868N x 20
 Black 12 inch Zip Ties

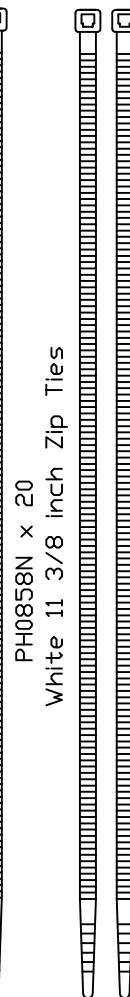

PH0858N x 20
 White 11 3/8 inch Zip Ties



PH0848N x 40
 Black 8 inch Zip Ties

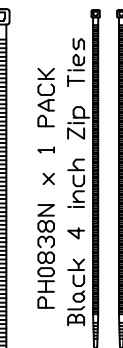

PH0838N x 1 PACK
 Black 4 inch Zip Ties

3A065A0D X 1

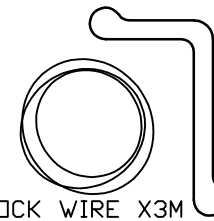

LOCK WIRE X3M

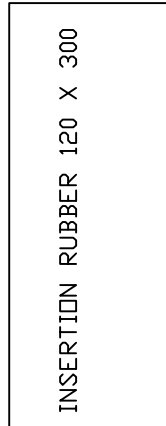

INSERTION RUBBER 120 X 300

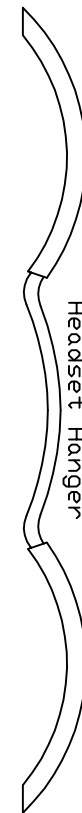

Headset Hanger
 P10149N x 1

CARD J16-4 : ELECTRIC FLAPS current as on 06-04-09

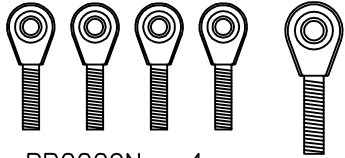

PB0009N x 4
3/16 ROD END

PB0112N x 1
1/4 ROD END

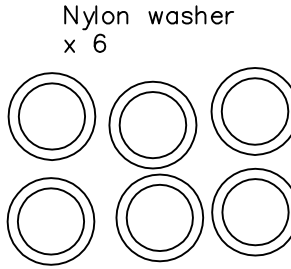

Nylon washer
x 6

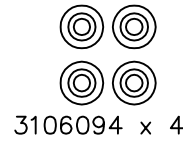

3106094 x 4

| DESCRIPTION | QTY | DESCRIPTION | QTY |
|--------------------------|-----|---------------------------|-----|
| AN960-416L-Half Washer | 4 | AN3-13A-Bolts | 3 |
| AN960-416-Full Washer | 7 | MS20365-1032-Nut Nyloc | 4 |
| AN316-3-Half Nut | 6 | PH9962N-P Clamp white | 4 |
| AN960-10-Full Washer | 8 | AN3-7A-Bolts | 6 |
| AN960-10L-Half Washer | 4 | AN3-10A-Bolts | 2 |
| MS20365-428-Nut Nyloc | 2 | MALE SPADE TERMINAL RED | 2 |
| AN4-11A-Bolt | 1 | FEMALE SPADE TERMINAL RED | 2 |
| PH0239N (1/4 UNF Plain) | 1 | Bundy tube 19mm | 1 |
| AN316-5R 5/16 HALF NUT | 2 | 3000B94 Spacer Rod | 3 |
| AN3-16 M/16" BOLT DRLD | 1 | AN960-516-Full Washer | 1 |
| 3A055HOD FLAP DRV MNT | 1 | Bundy Tube 8mm | 8 |
| 3A085BOD-SharftIndacater | 1 | | |
| 3A085COD-Indacaterwasher | 1 | | |

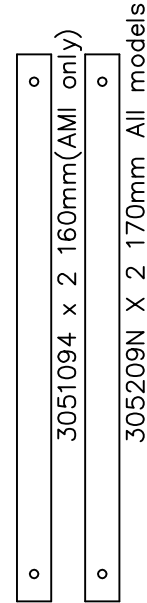

3051094 x 2 160mm(AMI only)

305209N X 2 170mm All models

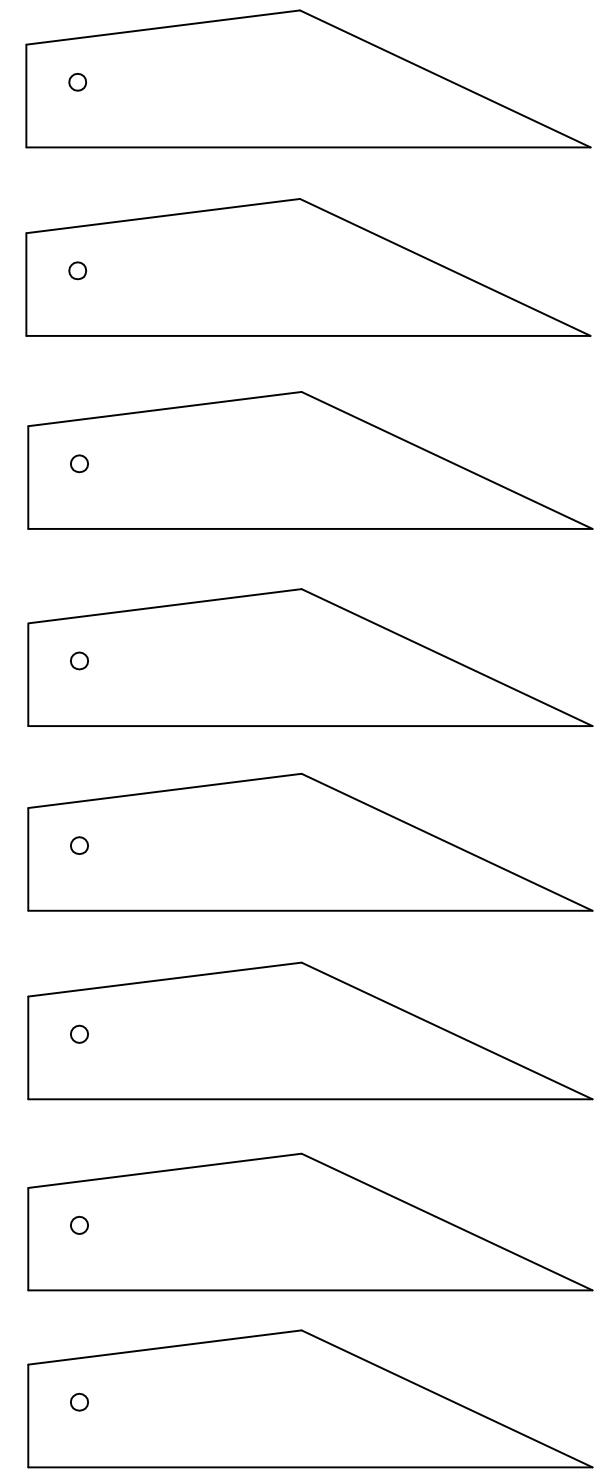

2026094 x 8

PC3A002 (Choke Cable
Inner and outer)x1

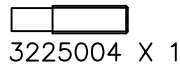

3225004 X 1

3A062BOD-2
X1

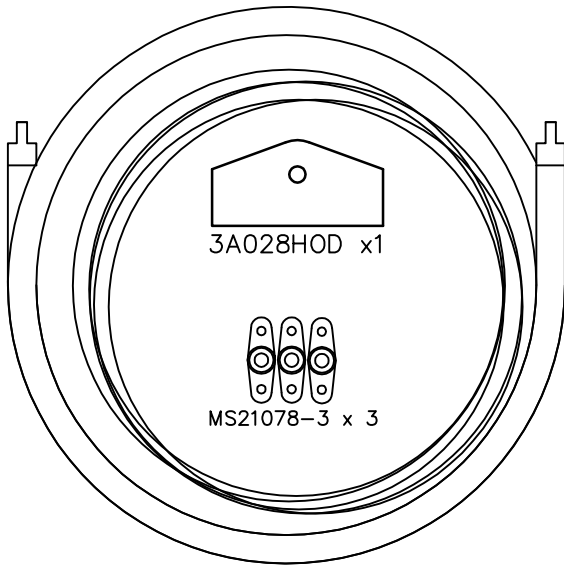
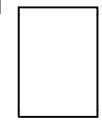

3A028HOD x1

MS21078-3 x 3

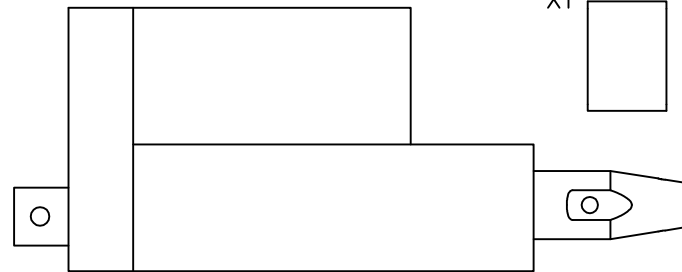

PM3A000N x 1 (ELECTRIC FLAP DRIVE)

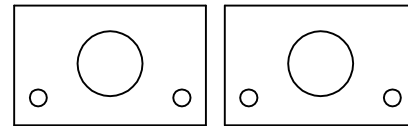

3003394 x 2

PI3A003A0N-1x1

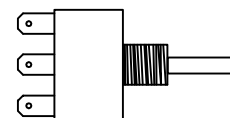

CARD JIT 17B-2: ELEVATOR SYSTEM AND CONTROL STICK CFI



J SERIES 3A093BOD X 1 T SERIES 3A081BOD X 1

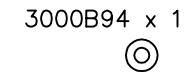
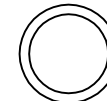
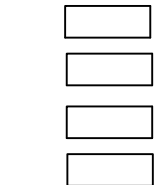
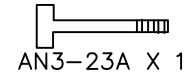
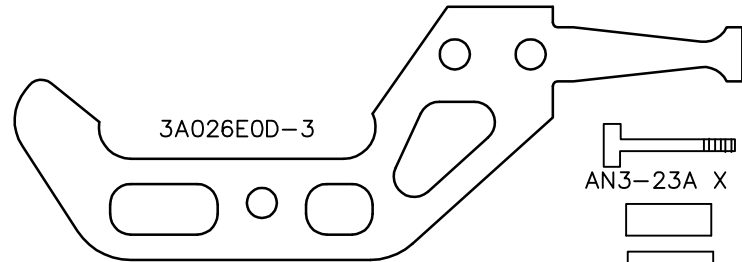
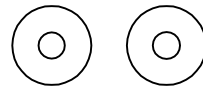
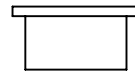
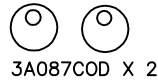
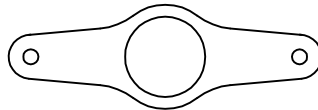
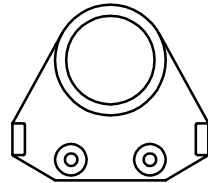
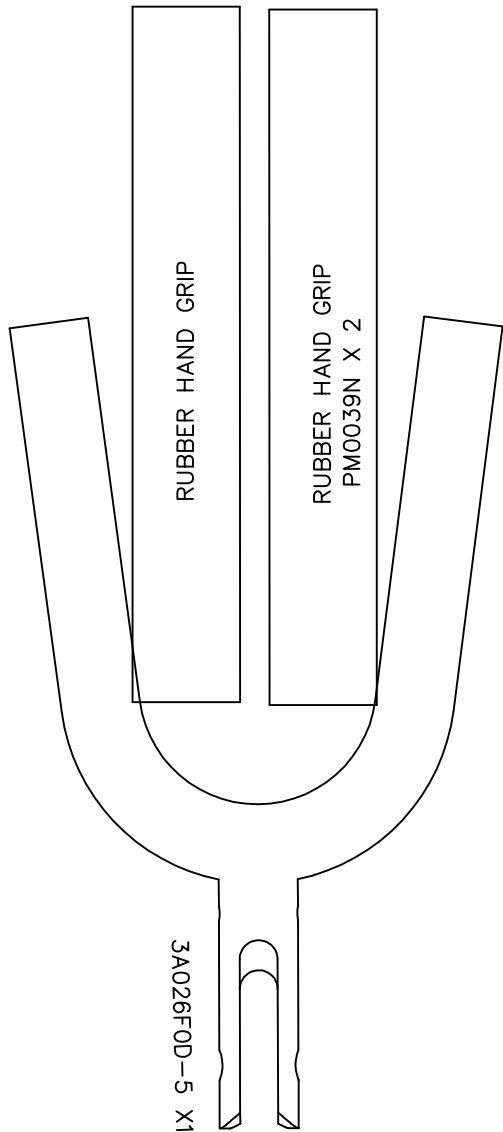

PB3A003N x 1

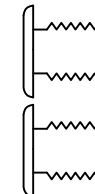

Spiral Wrap x 150mm

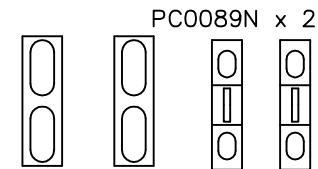

PC0099N x 2

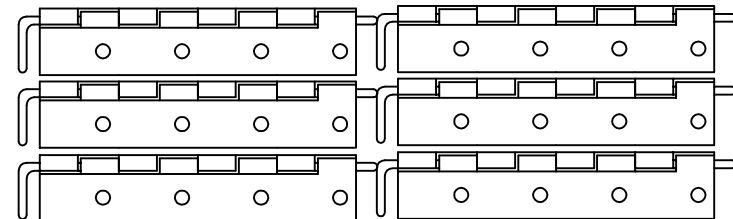

CARD J19-3 : NOSELEG Current as on 20-4-09

| DESCRIPTIONS: | QTY: |
|------------------------|------|
| 1 AN5-43 BOLT | 1 |
| 2 AN5-15A BOLT | 1 |
| 3 AN3-7A BOLT | 1 |
| 4 AN3-6A BOLT | 1 |
| 5 AN3-22A BOLT | 3 |
| 6 AN310-5 NUT | 1 |
| 7 MS20365-1032 NUT | 4 |
| 8 AN960-1032 WASHER | 3 |
| 9 AN960-516 WASHER | 6 |
| 10 AN380-2-2 SPLIT PIN | 1 |
| 11 MS20365-428 NUT | 2 |
| 12 MS20365-524 NUT | 1 |
| 13 AN960-416 WASHER | 2 |
| 14 AN4-16A BOLT | 1 |
| 15 AN970-4 | 1 |

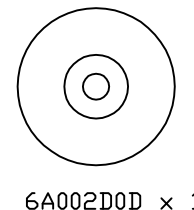
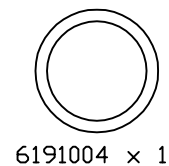
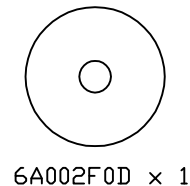
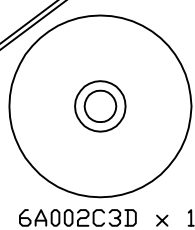
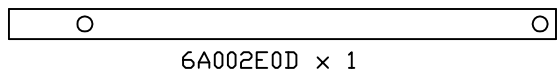
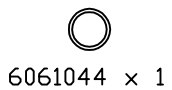
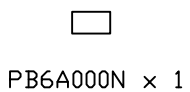
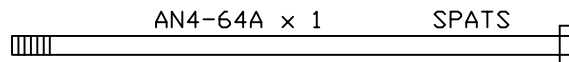
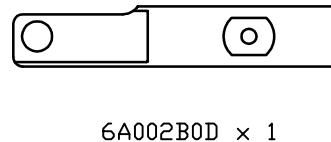
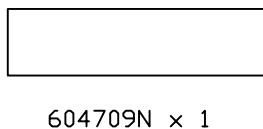
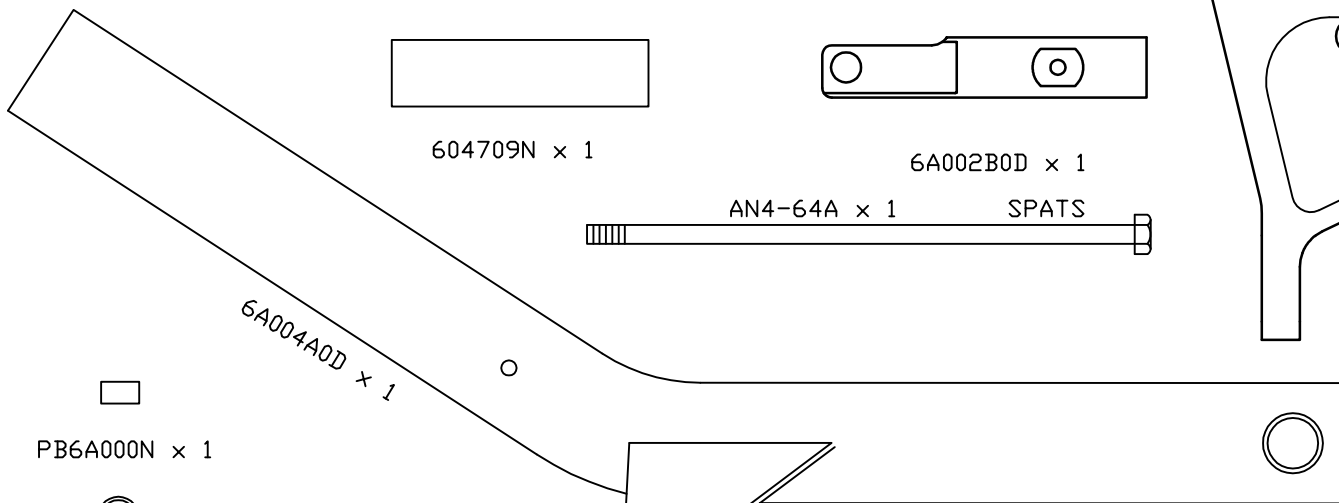
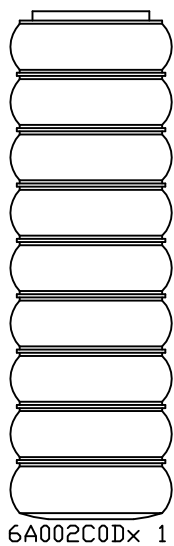
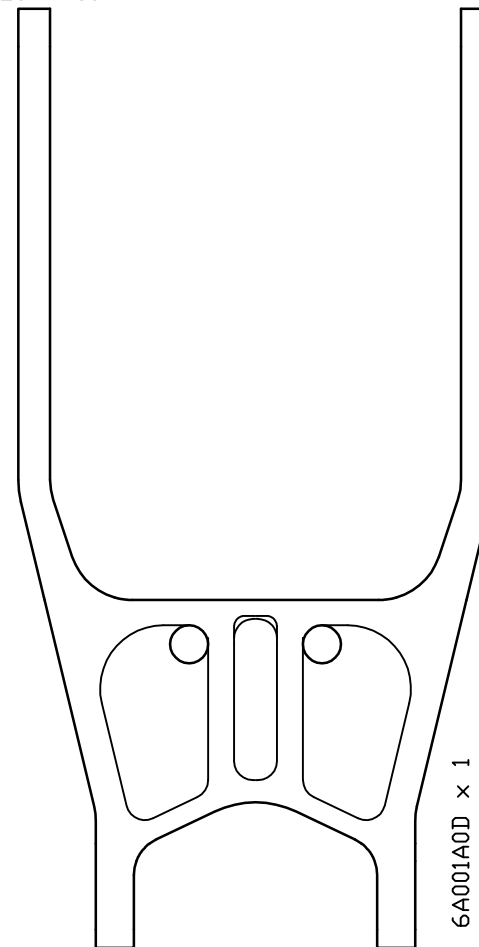
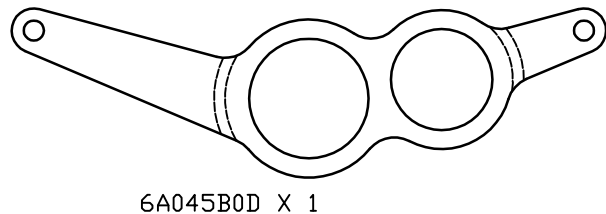
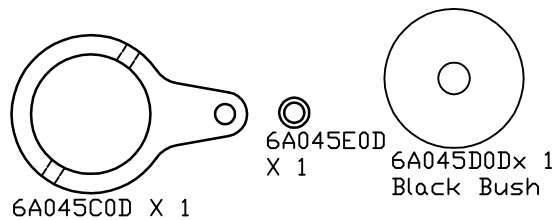

CARD **J|T** 20: NOSEWHEEL

6213123-1 x 1

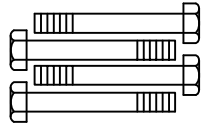

AN4-11A x 4



AN960-416 x 8



MS20365-428x 4

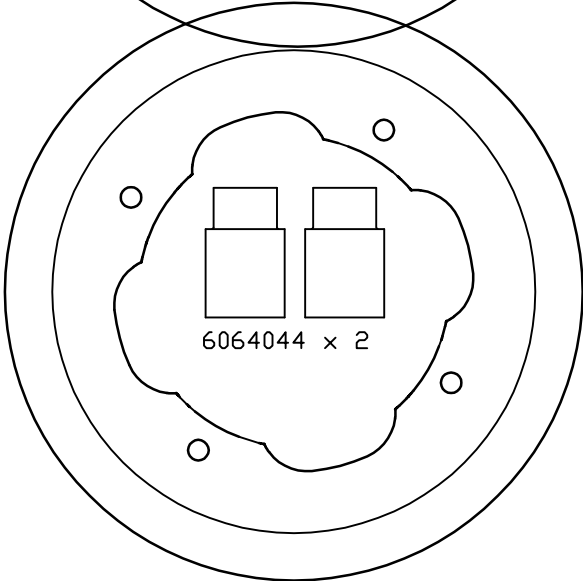
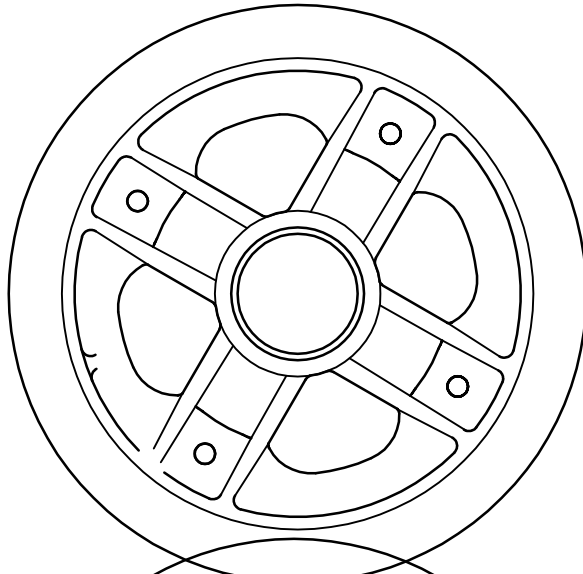

6211023-2 x 1



AXLE

6065044 x 1

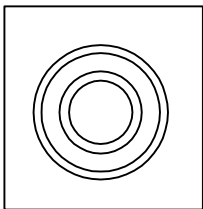

PB0029N x 2
BEARINGS

CARD **J|T** 20: NOSEWHEEL

6211023-2 x 1

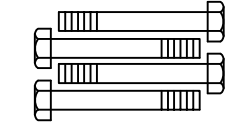

AN4-11A x 4



AN960-416 x 8

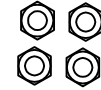

MS20365-428x 4

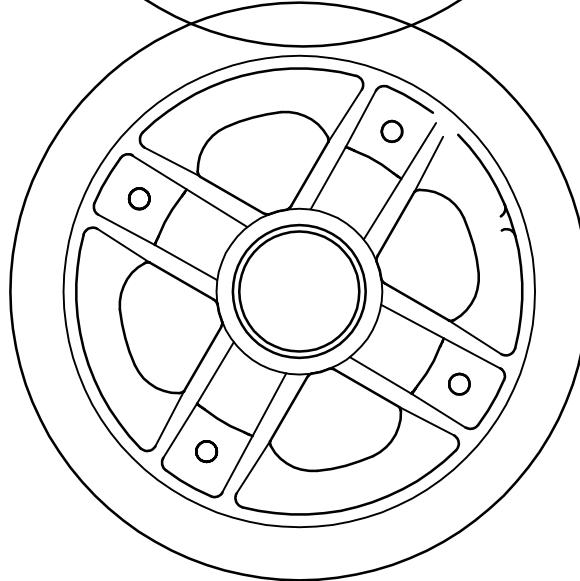
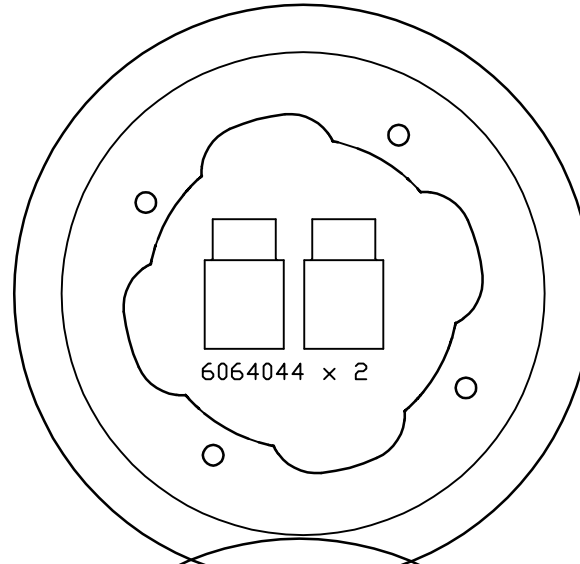

6213123-1 x 1



AXLE

6065044 x 1

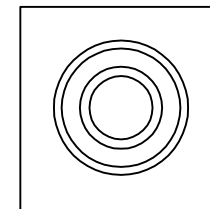

PB0029N x 2
BEARINGS

CARD J | T 21-2: MAIN WHEELS

PW0009N x 3
1 1/8 Grommet

6211023-2 x 1

6210023-2 x 1

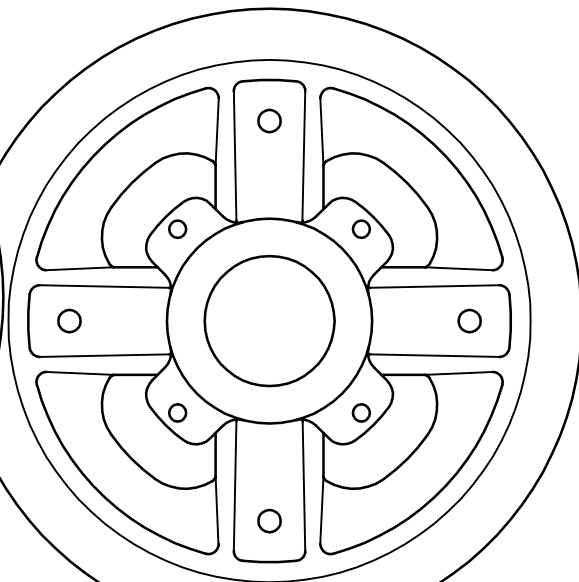
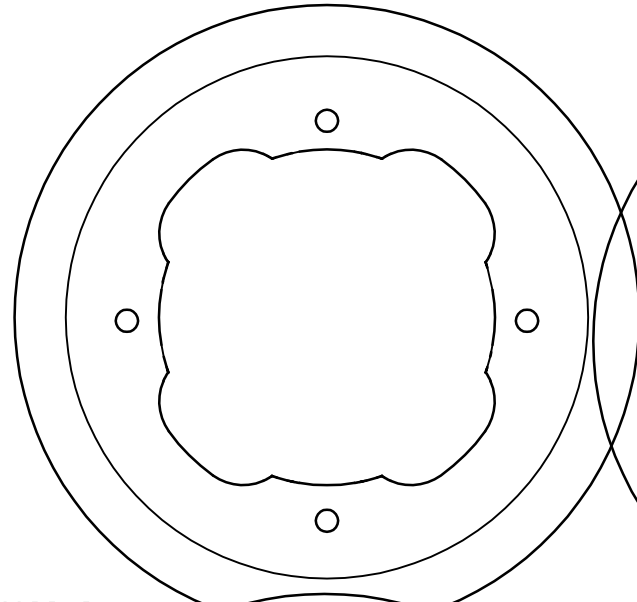

6210023-2 x 1

6211023-2 x 1

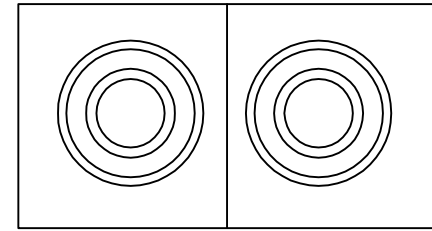
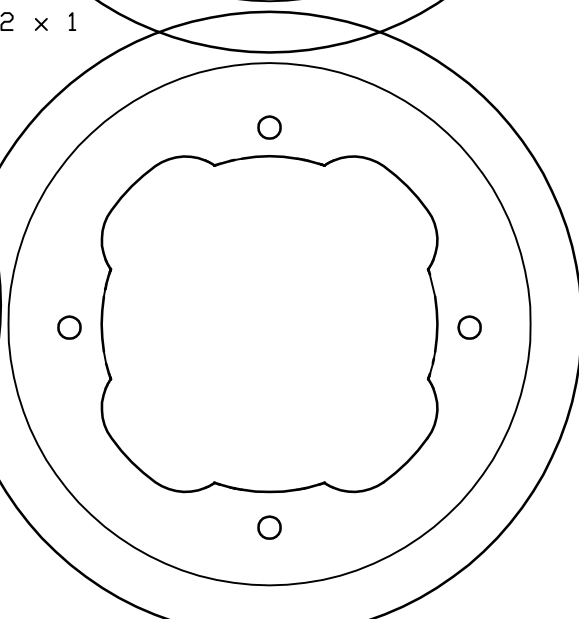
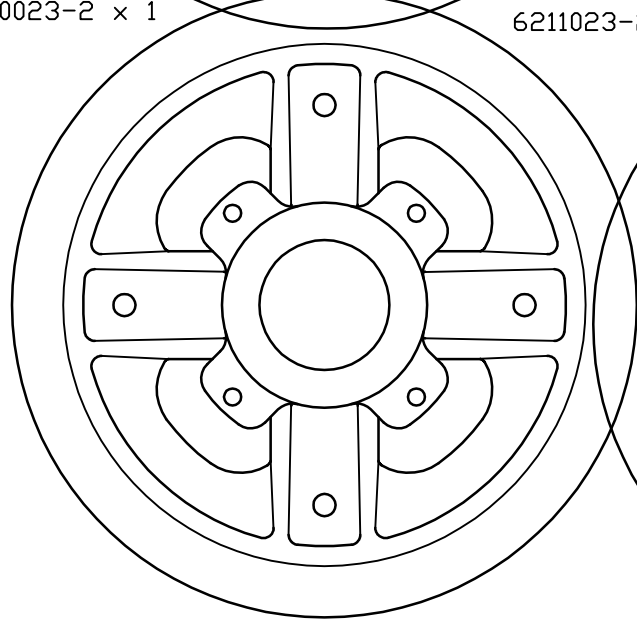

PB0029N x 4 (BEARINGS)

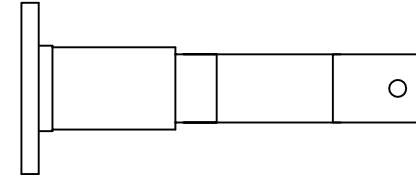

6A028B0D x 2

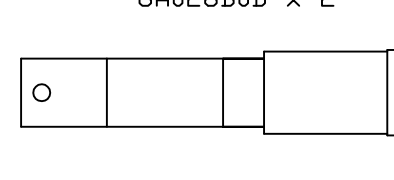

6A028C0D x 2

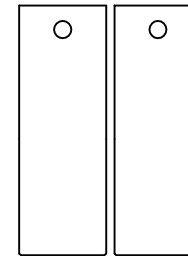

6000594 x 2

HD STUB AXLES

| | DESCRIPTIONS: | QTY: |
|----|------------------|------|
| 1 | AN4-11A BOLT | 8 |
| 2 | MS20365-428 NUT | 8 |
| 3 | AN960-416 WASHER | 16 |
| 4 | AN5-15A BOLT | 4 |
| 5 | AN5-16A BOLT | 4 |
| 6 | AN960-516 WASHER | 22 |
| 7 | MS20365-524 NUT | 8 |
| 8 | MS21047-3 | 8 |
| 9 | A3235-020-935 | 8 |
| 10 | MS246935273 | 8 |
| 11 | AN4-4A | 2 |
| 12 | AN960-416L | 4 |
| 13 | MS24693C47 | 10 |

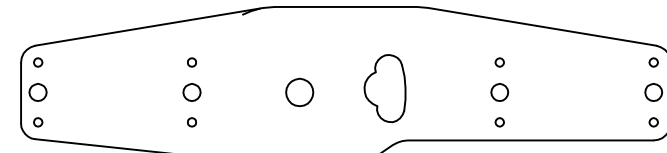

6A039A0D x 2

HOT AIR MIXER BOX COMPONENTS CARD JIT 22-2:

A- AE102/624- AS1072- 8 FIRESLEEVE

PQ0019N x 1 x 700

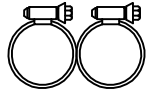

PV4A001N x 2

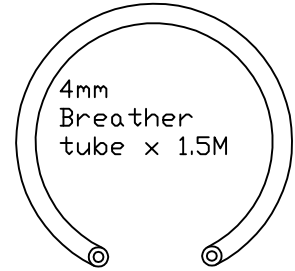

4mm
Breather
tube x 1.5M

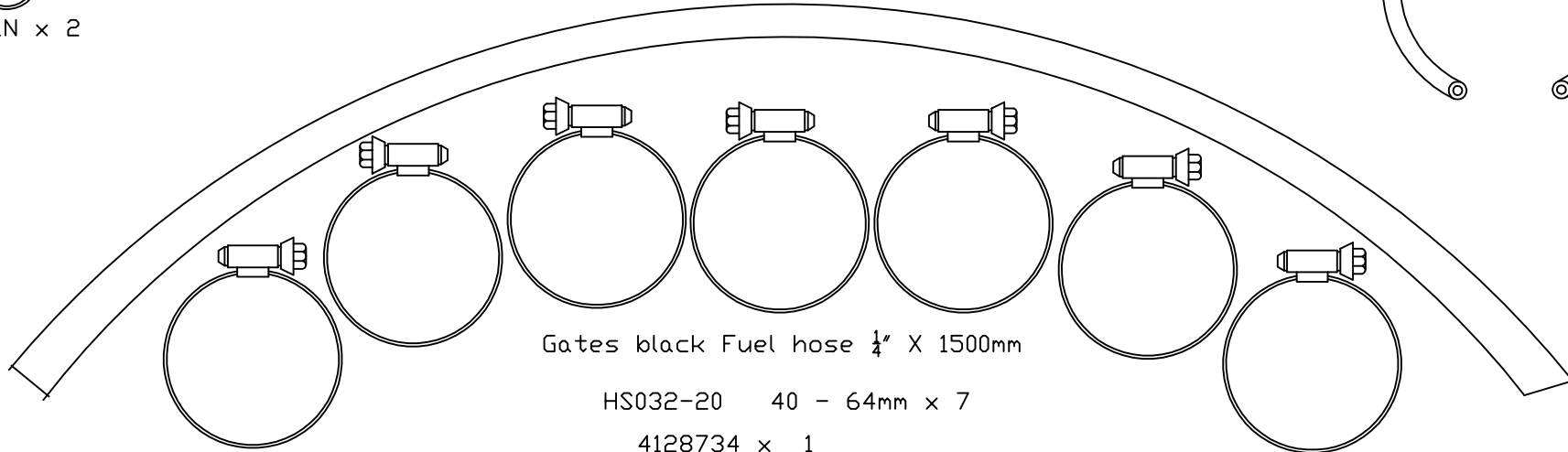

Gates black Fuel hose $\frac{1}{4}$ " X 1500mm

HS032-20 40 - 64mm x 7

4128734 x 1

2.25" SCATHOSE 1.4m

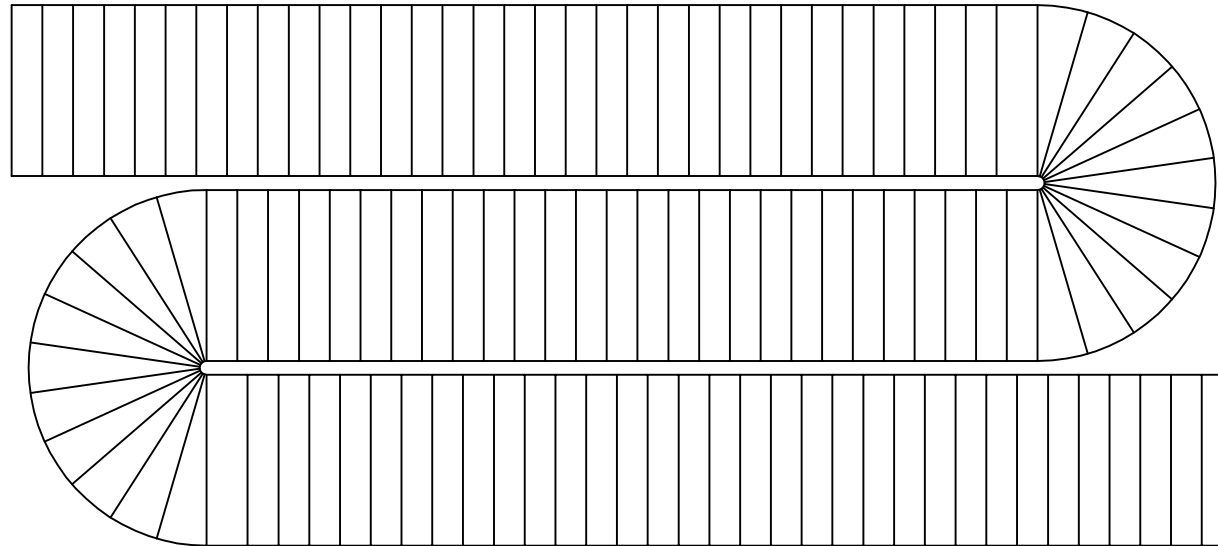

CARDJT 23-2: OIL BOTTLE, ENGINE, SPINNER HARDWARE

current as on 27-4-09

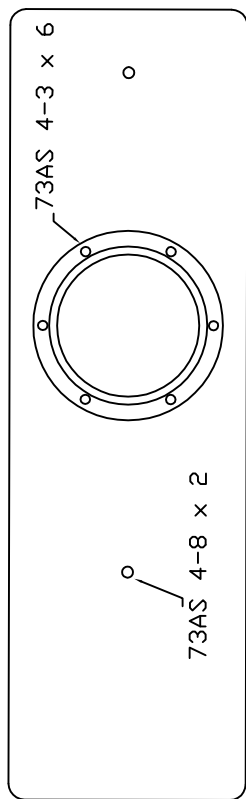

4089094 x 1

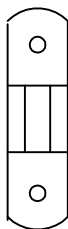
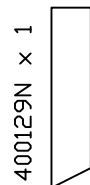

PV0040N x 1
HOSE SADDLE

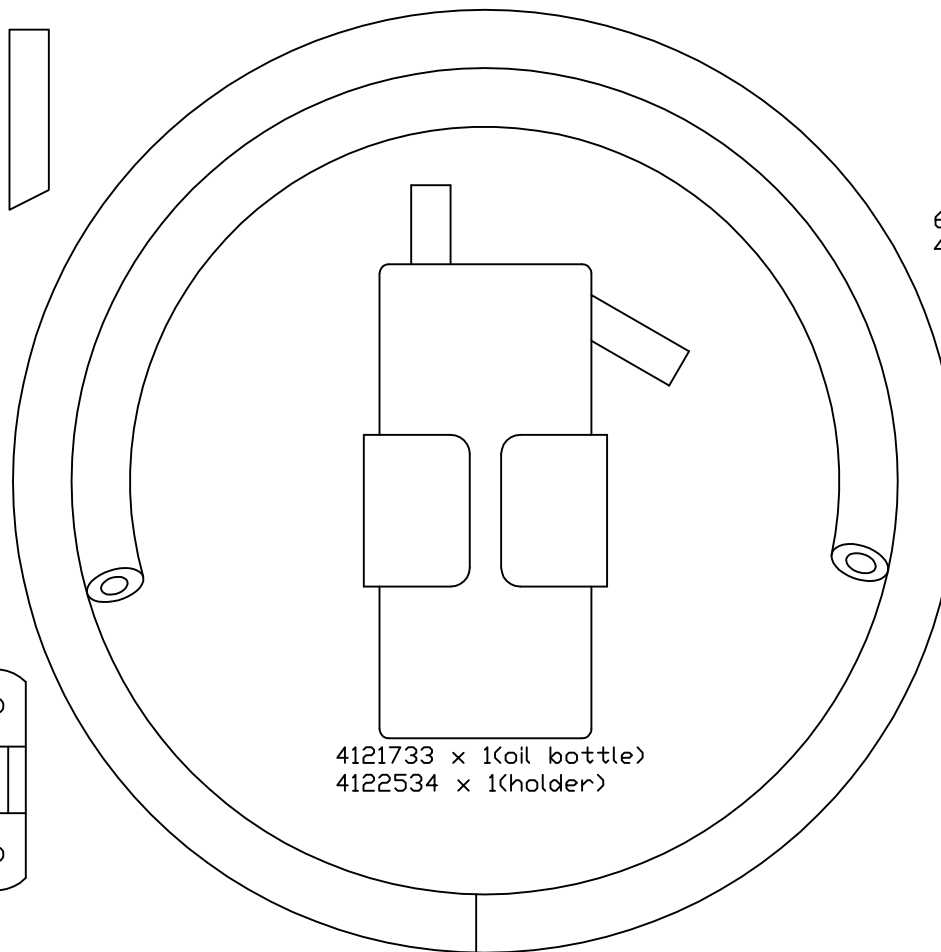

4121733 x 1(oil bottle)
4122534 x 1(holder)

412365N x 1
1/2 inch Heater Hose (1400mm)

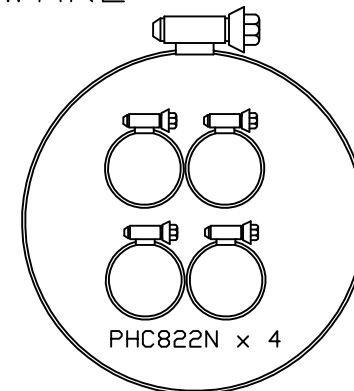

PHC822N x 4

6 Cyl HS060 105-130mm x 2
4 Cyl PHC8408 x 2

8G x 1/2 P/H



8G x 1/2 CSK x2

CARD JT 25-2: CABIN HEATER

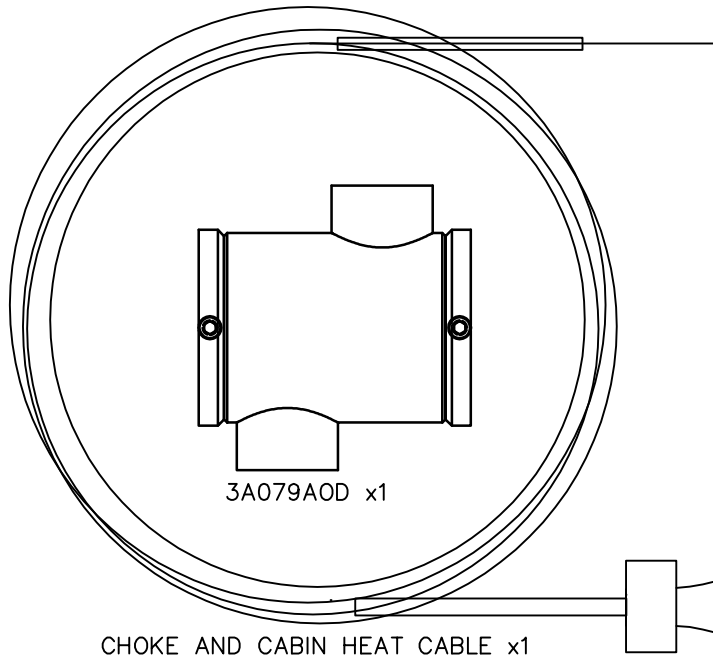

| DESCRIPTION | QTY |
|-----------------------------|-----|
| PX00394 Spring | 1 |
| 4615074 right angle bracket | 1 |
| 4A454CON | 1 |
| AN316-5R 5/16halfnuts unc | 2 |
| AN960-416 | 1 |
| 3/32 x 3/4 ROLL PIN | 1 |
| AN380-1-6 Split Pin | 1 |
| 73-AS-4-3 RIVET | 1 |
| M4 PLAIN NUT | 1 |
| M4 NYLOC NUT | 1 |
| 32250045/16threaded sleeve | 1 |
| 3/16x1/2UNC CAP SCREW | 4 |
| M4 x 25 PAN SCREW | 2 |
| MS35214-26 | 2 |
| 4A454BOD | 1 |

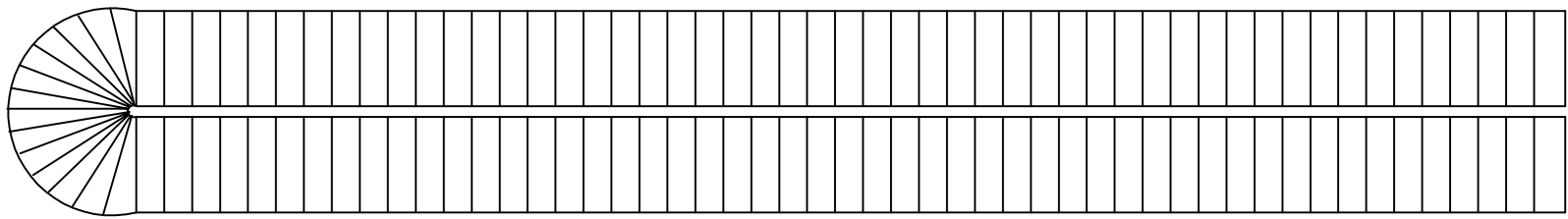
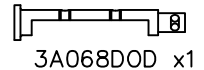
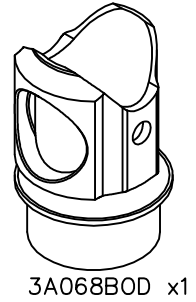
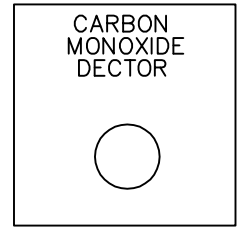
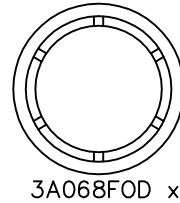
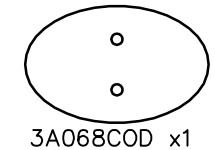
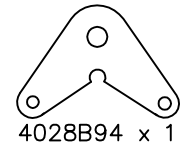
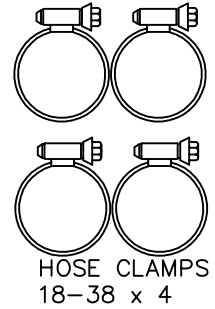
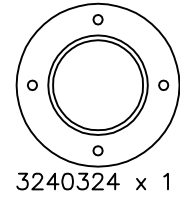

CARD J26: REAR SEAT HARDWARE current as on 24-4-09

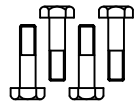

AN5-10A x 4

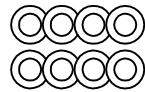

AN960-516 x 8

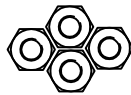

MS20365-524 x 4

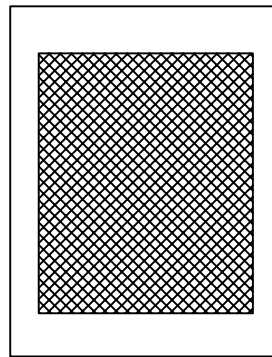

2" WIDE GLASS TAPE
2 x 3.2m, 2 x 1.65m



AN3-6A x 4

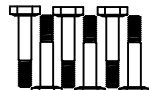

AN3-10A x 6

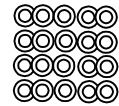

AN960-10 x 20



MS20365-1032
x 10

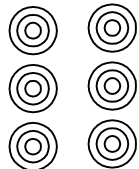

1109004 x 6

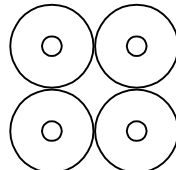

3042094 x 4

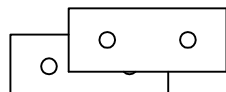

3128004 x 2

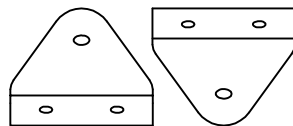

5000094 x 2

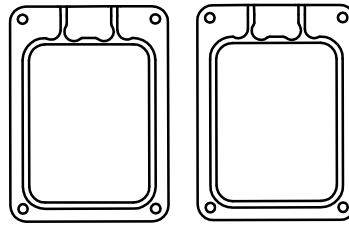

3A069B0D X 2

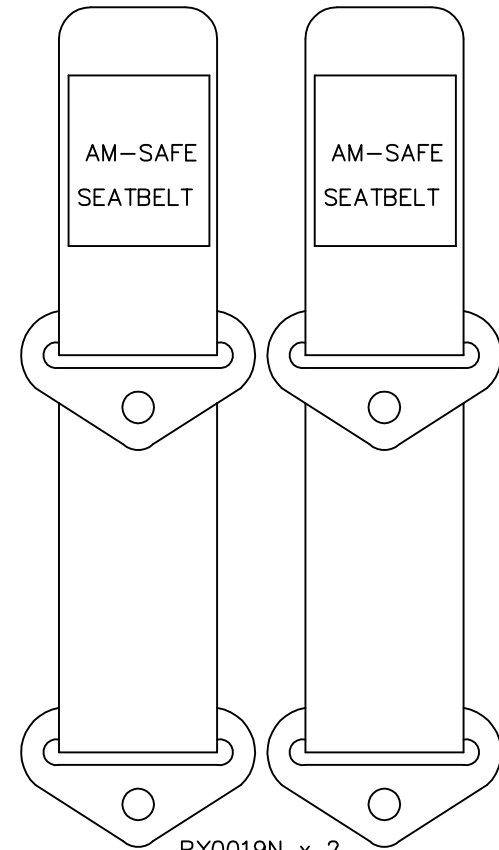

PY0019N x 2

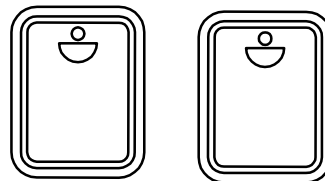

3A069C0D X 2

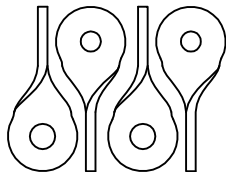

1108204 x 4

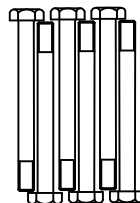

AN6-26A x 6

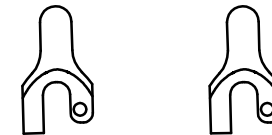

3A069D0D X 2

M4 NYLOC NUT X 2

M4 x 25Pan X 2 SCREW